

Pennsylvania Driver's Manual

(English Version)

- [Non-Commercial Learner's Permit Application](#)
- [Parent or Guardian Consent Form](#)
- [Introduction](#)
- [Table of Contents](#)
- [Index](#)

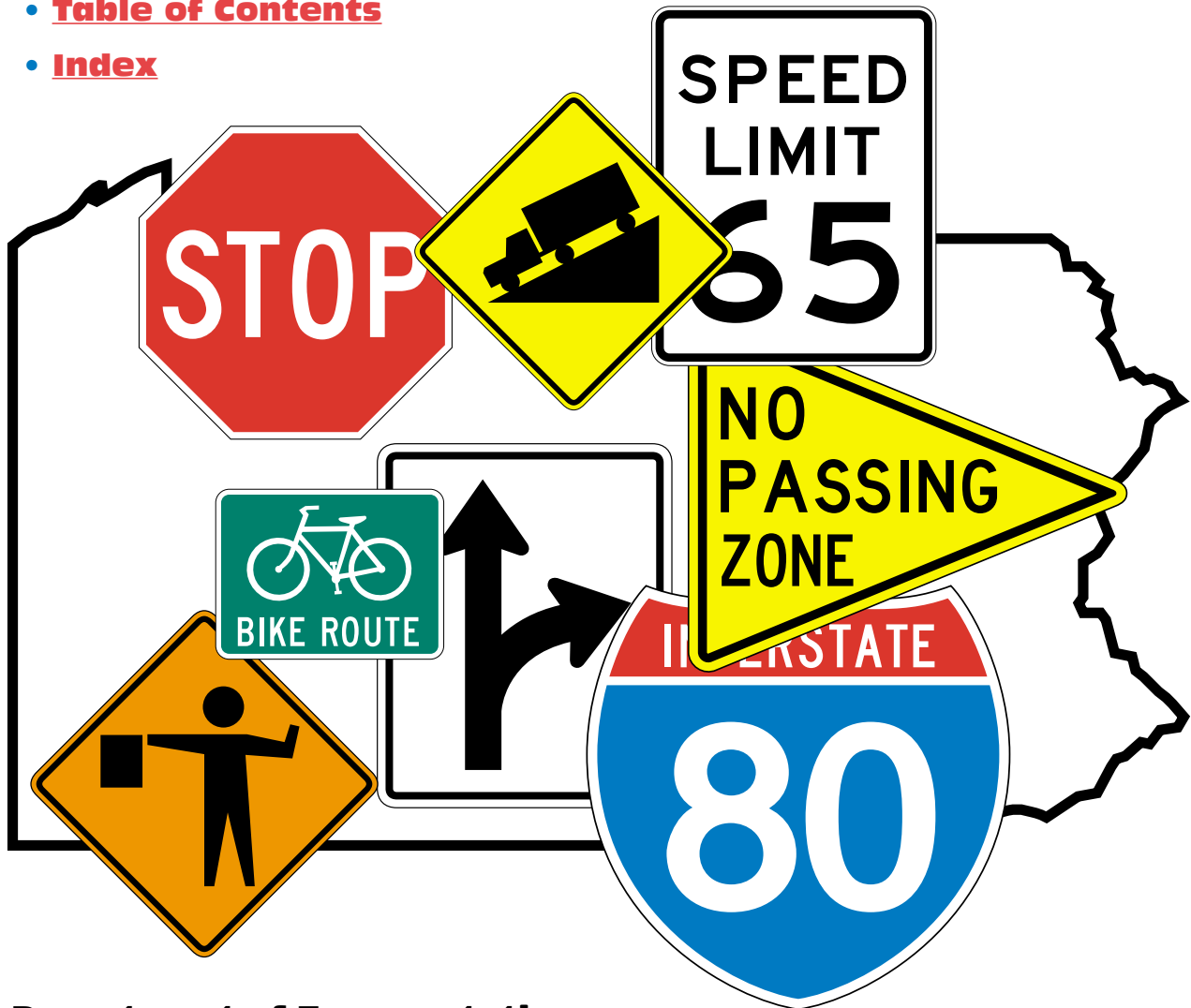

**Department of Transportation
Driver and Vehicle Services**

Pub. 95 (5-00)

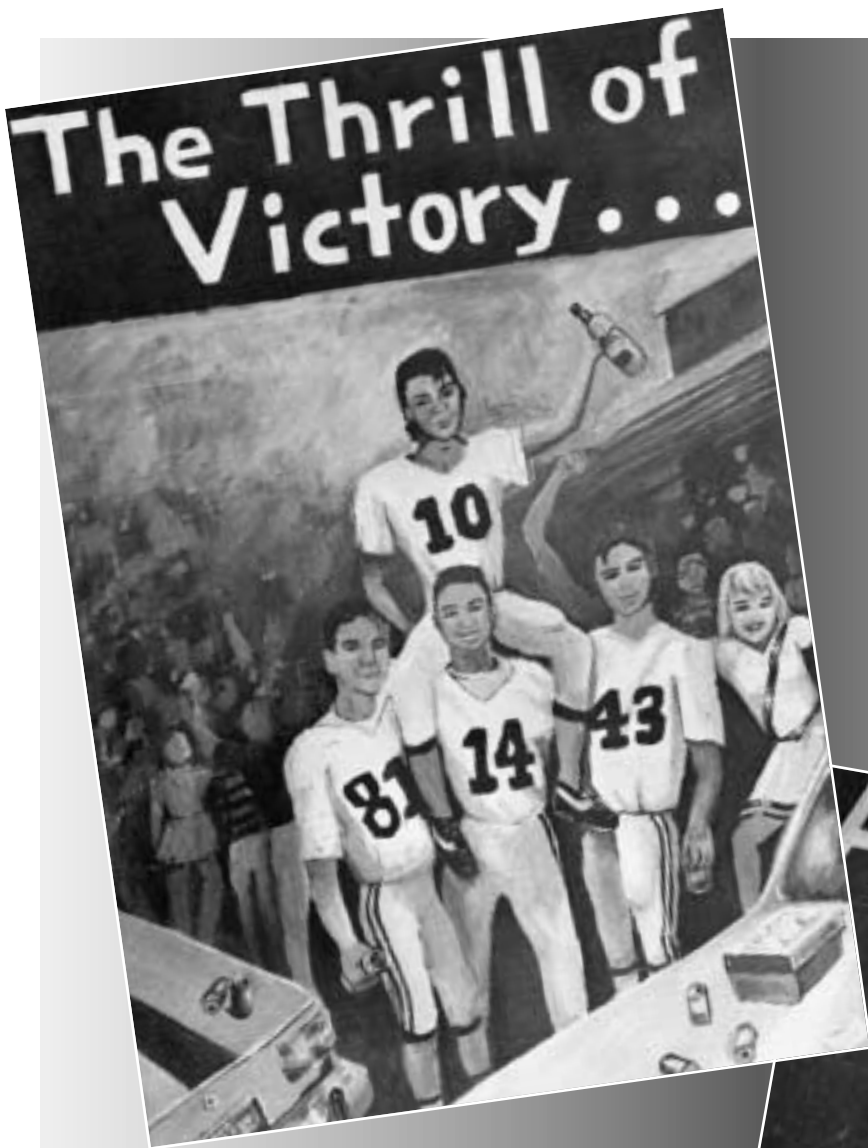

Poster by: Lynnsy Stepler, 10th Grade, Home School, Perry County as part of the Pennsylvania Liquor Control Board's 1995-96 Alcohol Awareness Education Program



NON-COMMERCIAL LEARNER'S PERMIT APPLICATION

PRINT ALL INFORMATION IN
BLACK OR BLUE INK

THIS FORM IS VALID FOR 1 YEAR FROM THE DATE OF PHYSICAL EXAMINATION
The physical date may not be more than 60 days prior to your 16th birthday.

DRIVER'S LICENSE NUMBER/I.D. NUMBER: _____

LAST NAME(S)														JR., ETC.	
FIRST NAME														MIDDLE NAME	

DATE OF BIRTH			HEIGHT		SOCIAL SECURITY NUMBER					SEX	TELEPHONE (8:00 a.m. to 4:30 p.m.)			
MONTH	DAY	YEAR	FEET	INCHES	-	-	-	-	-		()			

EYE COLOR (Please check one): BLUE BROWN GREEN HAZEL PINK BLACK GRAY DICHROMATIC OTHER _____

STREET ADDRESS								CITY (PO Box number may be used in addition to the actual address, but cannot be used as the only address)				STATE	ZIP CODE
----------------	--	--	--	--	--	--	--	--	--	--	--	-------	----------

PERMIT(S) DESIRED	FEE	ENTER FEE FOR EACH ITEM CHECKED
<input type="checkbox"/> CLASS A (Combination Vehicle over 26,000)	\$5.00	
<input type="checkbox"/> CLASS B (Truck or Bus over 26,000)	\$5.00	
<input type="checkbox"/> CLASS C (Automobile)	\$5.00	
<input type="checkbox"/> CLASS M (Motorcycle) MSEA Fee is included (see back for information)	\$9.00	

LICENSE REQUIRED	FEE	
<input type="checkbox"/> 4-Year Photo	\$24.00	
<input type="checkbox"/> 2-Year Photo Age 65 & Over	\$14.00	
<input type="checkbox"/> Organ Donation Awareness Trust Fund	\$1.00	

PAID BY: Check Money Order **TOTAL** \$ _____

ALL QUESTIONS MUST BE ANSWERED (Check [✓] Applicable Blocks) YES NO

- Have you ever held or possessed a PA Driver's License/Learner's Permit/Photo Identification Card? YES NO
- Is your right to apply for a license or your privilege to operate a vehicle in this or any other state currently suspended or revoked? YES NO
If yes, give state _____ date _____, and reason _____
- Have you been arrested or cited in this state or any other state for any violation which carries a possible penalty of suspension or revocation of your driver's license or driving privilege? YES NO
If yes, give state _____ date _____, and reason _____

AUTHORIZATION AND CERTIFICATION

I certify under penalty of law that this information contained herein is true and correct. I hereby authorize the Social Security Administration to release to the Department of Transportation information concerning my Social Security Identification Number for the purpose of identification. I hereby acknowledge this day that I have received notice of the provisions of Section 3709 of the Vehicle Code. (See back for provisions)

WARNING: Misstatement of fact is a misdemeanor of the third degree punishable by a fine of up to \$2,500 and/or imprisonment up to 1 year (18 PA C.S. Section 4904[b]).

- I am under the age of 18 years and I hereby request Organ Donor designation on my PA Driver's License. Parent must check consent block on the Parent/Guardian Consent Form (DL-180TD). (Applicants 18 years of age or older will have the opportunity to request Organ Donor designation at the Photo Center at the time they have their photo taken.)
- I wish to contribute \$1.00 to the Organ Donation Awareness Trust Fund.

X _____ (APPLICANT'S SIGNATURE IN INK) _____ (DATE)

FOR PENNDOT USE ONLY

Exam Center: _____	Date: _____	MEDICAL RESTRICTIONS: _____
Signature of Examiner: _____	Badge No.: _____	<input type="checkbox"/> QUALIFIED YES <input type="checkbox"/> UNABLE TO DETERMINE MEDICAL QUALIFICATIONS

VERIFICATION OF BIRTH DATE AND IDENTITY: BIRTH CERTIFICATE OTHER _____

ALL INFORMATION IN THIS SECTION MUST BE COMPLETED IN FULL BY A MEDICAL PROVIDER

Physician's Report of Examination

(Check [✓] Applicable Block) **YES** **NO**

1. Neurological disorders such as to prevent reasonable control of a motor vehicle?
2. Any Cardiac or Circulatory disorder including Hypertension such as to prevent reasonable control of a motor vehicle?
3. Neuropsychiatric disorders such as to prevent reasonable control of a motor vehicle?
4. Conditions causing repeated lapses of consciousness, e.g. epilepsy, narcolepsy, hysteria, etc.?
If yes, specify: _____ If seizure disorder, date of last seizure _____
5. Alcoholism?
6. Narcotic Addiction?
7. Uncontrolled Diabetes?
8. Uncontrolled Epilepsy?
9. Immobility or Amputation of an Appendage?
If so, list: _____
10. Does this person have any other condition that would prevent control of a motor vehicle?
If yes, list: _____

NOTE: Any recommendations/additional comments must accompany this certificate on physician letterhead enclosure

PHYSICIAN INFORMATION <i>(Please print or type)</i>				CHECK ONE: <input type="checkbox"/> M.D. <input type="checkbox"/> D.O. <input type="checkbox"/> C.R.N.P. <input type="checkbox"/> P.A. <input type="checkbox"/> O.S.			
NAME		STATE LICENSE NUMBER		TELEPHONE NUMBER			
STREET ADDRESS		CITY		STATE		ZIP CODE	
PHYSICIAN'S SIGNATURE		PHYSICAL DATE		EXAMINEE'S SIGNATURE (SIGN ONLY IN PRESENCE OF PHYSICIAN)			

YOU MUST BRING YOUR SOCIAL SECURITY CARD ALONG WITH ONE OF THE FOLLOWING:

ACCEPTABLE FORMS OF IDENTIFICATION (Must Contain Date of Birth)

- Birth Certificate, Certification of Birth *(State issued with raised seal)*
- Certificate of Naturalization *(INS Form N-550 or N-570)*
- Certificate of United States Citizenship *(INS Form N-560)*
- Non-resident Out-of-State Driver's License
- Pennsylvania Photographic ID Card
- Registration Receipt Cards *(INS Form I-151 or I-1551)*
- Valid U.S. Passport
- Valid Foreign Passport *(accompanied by an I-94)*
- Pennsylvania Photographic Driver's License
- Military Photo ID Card
- Marriage Record *(must contain your date of birth)*
- Pennsylvania Learner's Permit *(valid or expired)*

FEES: REQUIRED ITEMS AND FEE INFORMATION - CASH CAN NOT BE ACCEPTED

TYPE OF PERMIT/LICENSE	TOTAL	LICENSE FEE	PERMIT FEE	MSEA FEE	PHOTO FEE
Initial Permit & 4-Year License	\$29.00	\$20.00	\$5.00	---	\$4.00
Initial Class M Permit & 4 Year License	\$33.00	\$20.00	\$5.00	\$4.00	\$4.00
Initial Permit & 2 Year License (age 65+)	\$19.00	\$10.00	\$5.00	---	\$4.00
Initial Class M Permit & 2 Year License (age 65+)	\$23.00	\$10.00	\$5.00	\$4.00	\$4.00

ORGAN DONATION AWARENESS TRUST FUND (ODTF): You have the opportunity to contribute \$1.00 to the Fund. The additional \$1.00 contribution must be **added** to the fee above and included in your payment by check/money order.

Permit Fee: Additional permit fee of \$5.00 for each permit requested.

MSEA Fee: These additional fees are required under the Pennsylvania Vehicle Code Section 7904 and will be used to support a Motorcycle Safety Education Program in the Commonwealth of Pennsylvania.

PROVISIONS OF SECTION 3709 OF THE VEHICLE CODE

Section 3709 provides for a fine of up to \$300 for dropping, throwing or depositing, upon any highway, or upon any other public or private property without the consent of the owner thereof or into or on the waters of this Commonwealth, from a vehicle, any waste paper, sweepings, ashes, household waste, glass, metal, refuse or rubbish or any dangerous or detrimental substance, or permitting any of the preceding without immediately removing such items or causing their removal.



PARENT OR GUARDIAN CONSENT FORM

(PRINT NAME OF APPLICANT)

I hereby certify that I am the minor applicant's Parent Guardian Person in Loco Parentis or Spouse, and that I am at least 18 years of age.

I also certify that:

- ◆ This application is made with my full consent.
- ◆ I understand if I want to withdraw my consent at any time before this minor applicant reaches the age of 18, PennDOT will cancel his or her driver's license.
- ◆ I understand that I will be required to ensure that this applicant will have to complete at least 50 hours of supervised practical driving experience before he or she will be permitted to take the drivers test. The supervising adult must be at least 21 years of age or older.
- ◆ I understand that PennDOT recommends that the supervising adult refer to PennDOT's Parent or Guardian-Teen Driver Guide when teaching the minor applicant how to drive.

I DO DO NOT give consent for applicant's request for Organ Donor designation.

 X
(SIGNATURE OF PARENT, GUARDIAN, PERSON IN LOCO PARENTIS OR SPOUSE AT LEAST 18 YEARS OF AGE)

 X
(PRINT NAME AS IT APPEARS IN SIGNATURE)

SUBSCRIBED AND SWORN			
TO BEFORE ME:	MO.	DAY	YEAR
Signature of Person Administering Oath			
S E A L	SIGN IN PRESENCE OF NOTARY OR DRIVER LICENSE EXAMINER		

DL-180PG (12-99)

PARENT OR GUARDIAN NOTIFICATION

I authorize PennDOT to release my driver's record
to my parent or guardian.

SIGNATURE

PRINT NAME AS IT APPEARS IN SIGNATURE

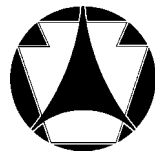

INTRODUCTION

This manual is designed to help you become a safe driver. *It presents many of Pennsylvania's laws governing driving. It should be used as a general guide to the laws but not as a substitute for the Vehicle Code, which contains the laws affecting Pennsylvania's drivers and vehicles. It should also be noted that the information contained in this manual is subject to change.*

The purpose of this manual is to prepare you to take the driver's examination and to obtain a Pennsylvania driver's license. However, the rules of the road and traffic operation principles presented in this manual apply to the three types of vehicles recognized by Pennsylvania law: bicycles, horse-drawn vehicles and motor vehicles. For example, ALL bicyclists, just like motorists, are required to stop at red lights.

If you are now learning to drive, this manual will give you all the information you need to study for the driver's examination. If you already have a Pennsylvania driver's license, you can use this manual to review some of the rules of the road that you may have forgotten or to learn about some of the rules that may be new or have changed since you received your license.

Driving is a privilege and not a right. This privilege comes with many responsibilities. One very important responsibility is that you never mix drinking and driving.

**For the days and hours of operation
of a Driver License Center near you,
please call 1-800-932-4600.**

**Read this manual carefully, become a safe driver
and enjoy your driving privilege in our beautiful state.**

Courtesy of
Pennsylvania Department of Transportation

THIS PUBLICATION IS NOT FOR SALE

Chapter I - Non-Commercial Learner's Permit Information1
 Applying for a Learner's Permit and Driver's License1
 Tests4

Chapter II - Signals, Signs and Pavement Markings7
 Signals7
 Signs10
 Pavement Markings21

Chapter III - Learning to Drive23
 Vehicle Safety and Emissions Inspection23
 Preparing to Drive23
 Developing Your Driving Skills28
 Adjusting Speed41
 Special Circumstances44
 Emergency Driving Skills50
 Keeping in Shape for Driving53
 Trip Planning54

Chapter IV - Driving Record Information56
 Pennsylvania's Point System56
 Crashes58
 Driving Under the Influence of Alcohol or a Controlled Substance59
 Underage Drinking61
 Controlled Substance, Drug, Device and Cosmetic Act62
 Driver's License Compact (DLC)62

Chapter V - Laws and Important Issues64
 Required Notification for Change in Name or Address64
 Seat Belt Law64
 Child Restraint Law64
 Air Bag Safety Information65
 Americans with Disabilities Act (ADA)65
 Parking Areas for Persons with Disabilities66
 Organ Donor Designation66
 Anti-Littering Law66
 Bicycle Helmet Law67
 Passengers in an Open Bed Truck67

Chapter VI - References68
 Customer Call Center68
 Road Test and Special Point Examination Appointments68
 Customer Correspondence Mailing Address68
 Departmental Forms and Publications68
 Internet69
 Statewide and County Maps70
 Information on Other Programs70

NON-COMMERCIAL LEARNER'S PERMIT INFORMATION

This chapter will provide the information you need to know about obtaining a Pennsylvania learner's permit. The areas addressed include:

- Applying for a Learner's Permit
- Tests

APPLYING FOR A LEARNER'S PERMIT

You must obtain a learner's permit before you operate a motor vehicle in Pennsylvania.

When you are 16 years of age, or older, please follow the steps listed below in order to get your Non-Commercial Learner's Permit.

1. Please complete the front of the Non-Commercial Learner's Permit Application (DL-180) found in the front of this manual. Print clearly and neatly in black or blue ink. This form may be completed no earlier than 60 days prior to your 16th birthday.
2. Your medical provider must complete the back of the Non-Commercial Learner's Permit Application (DL-180). The form must be completed by a D.O. (Doctor of Osteopathy), M.D. (Medical Doctor), C.R.N.P. (Certified Registered Nurse Practitioner), P.A. (Physician's Assistant), or an O.S. (Osteopathic Physician & Surgeon). **All information must be completed.**
If the examiner cannot determine whether the information on the Non-Commercial Learner's Permit Application meets medical standards, your learner's permit may be delayed. You may be required to undergo additional medical examinations. If you have a condition that seriously impairs your ability to drive, you may be required to get a dual control learner's permit and learn to drive with a certified instructor.
3. If you are under 18 years of age your parent, guardian, person in loco parentis or spouse who is 18 years of age or older must complete the Parent or Guardian Consent Form (DL-180TD) also found in the front of this manual. Proper Identification is required and if last names are different, verification of relationship is needed.
4. You will need to take and pass the following three (3) tests to get your license: Vision, Knowledge and Road Tests.

After studying the manual and following the steps listed above, **bring the items listed below to the Driver License Center** when you are ready to take your Knowledge Test:

- Your completed Non-Commercial Learner's Permit Application (DL-180) — **DO NOT MAIL THIS FORM** (If under 18 years of age, also bring your completed Parent or Guardian Consent Form (DL-180TD)),
- Proof of date of birth and identification. These documents must be originals (photocopies will **NOT** be accepted). The only acceptable proof of identification can be found on the back of the DL-180 (Non-Commercial Learner's Permit Application),
- Your social security card or acceptable proof of your social security number (e.g. a letter from the Social Security Administration), Military ID (you must bring original, photocopies will not be accepted),
- Your check or money order made payable to Pennsylvania Department of Transportation (PennDOT) for the correct amount. **CASH CAN NOT BE ACCEPTED.**

Please Note: FORMS OF IDENTIFICATION that may be used to prove your date of birth are listed on the back of the Non-Commercial Learner's Permit Application (DL-180) along with the dollar amounts owed. (All birth certificates/certification of birth must be state issued).

At the Driver License Center, your vision will be tested. If you wear glasses or contact lenses, please bring them with you. You will then take the Knowledge Test on signs, laws, driving rules and practices

described later in this manual. After passing the Knowledge Test, the examiner will give you a learner's permit which is valid for one (1) year. When you receive your learner's permit, you may begin to practice driving.

If you are under the age of 18, you are required to complete at least 50 hours of behind-the-wheel skill-building before taking your Road Test. This training will help teach you the skills necessary to become a good, safe driver.

After you have waited the mandatory 6 months from your permit issue date and have a signed certificate of completion for the 50 hours of skill-building, you may take your Road Test. If your learner's permit expires or if you do not pass your Road Test after three (3) tries, you may obtain an Application to Add/Extend/Replace/Change/Correct Non-Commercial Learner's Permit (Form DL-31).

REMEMBER: A driver licensed in Pennsylvania who is at least 21 years of age or a spouse, guardian, or parent who is at least 18 years of age must ride with you in the front seat of your vehicle at all times. In addition, drivers under the age of 18 cannot have more passengers in the vehicle than the number of seat belts.

If you fail the knowledge test, the examiner will return the Non-Commercial Learner's Permit Application and your Parent or Guardian Consent Form to you. You may take the knowledge test only one time on any day regardless of test location. Keep your forms in a safe place since you must bring them with you when you are tested again. The forms are valid for one (1) year from the date of your physical examination; however, the physical examination date may not be more than 60 days prior to your 16th birthday.

If you are using your learner's permit for driving outside of the state of Pennsylvania, please check with your insurance company and the other state's Department of Transportation to make sure your learner's permit is valid.

If any information on your learner's permit is not correct, bring proof of the correct information to the examiner when you come to the Driver License Center for testing.

Social Security Number Information

The Department is required by law to obtain your social security number, height and eye color under the provisions of Section 1510(a) and/or 1609(a)(4) of the Pennsylvania Vehicle Code. The information will be used as identifying information in an attempt to minimize driver license fraud. Your social security number is not part of your public driver's record. Federal law permits the use of the social security number by state licensing officials for purposes of identification. Your social security number will not be printed on your learner's permit or driver's license.

Pennsylvania Vision Standards

You may have poor vision in either eye and still be able to obtain a driver's license; however, you may be required to wear glasses or contact lenses, be restricted to daylight driving or be allowed to operate only vehicles equipped with outside mirrors.

If your vision fails to meet the vision standards, the examiner will give you a Report of Eye Examination (Form DL-102). You should have an optometrist, ophthalmologist or family physician test your vision and complete this form. When the form is completed, you may return to the Driver License Center to continue testing.

Who Needs a Pennsylvania Driver's License?

- **Foreign License Holders:** Pennsylvania honors a valid foreign driver's license with an international driving permit for a period of up to one year. If the foreign license and/or international driving permit expires before one year, the individual must apply for a Pennsylvania learner's permit to continue to drive in this state. An international driving permit is required **ONLY** if the foreign license is from a country that is not a

part of the Geneva Convention or the foreign license is not in English. All holders of foreign licenses **MUST** apply for a Pennsylvania learner's permit if they wish to obtain a Pennsylvania driver's license. Reciprocity agreements exist with the countries of France and Germany allowing for the transfer of a valid non-commercial license without skills or knowledge testing; a visual screening test will be administered.

- **People living in Pennsylvania** who are at least 16 years of age and want to drive a motor vehicle.
- **People who just moved into Pennsylvania** and are establishing Pennsylvania residency. If you hold a valid driver's license from another state, you must get a Pennsylvania driver's license within 60 days after moving to Pennsylvania and surrender your out-of-state license.
- **People in the United States Armed Forces** whose legal address is in Pennsylvania. This includes members of the reserve components stationed in Pennsylvania, who must get a license to operate a non-military vehicle.

Junior Permit Information

When you apply for your learner's permit and you are under the age of 18, you will be asked to sign a Parent or Guardian Notification Form (DL-180PG) giving the Department permission to provide your parent or guardian information related to your driving record. **If you do not sign the form, you will not be permitted to obtain a learner's permit.**

Your learner's permit will be valid for one (1) year from the date you pass your knowledge exam. During this time there are certain limitations on your driving privilege. They are:

- You may only drive under the supervision of a driver licensed in Pennsylvania who is at least 21 years of age or a spouse, guardian, or parent who is at least 18 years of age. The supervising driver must sit in the front passenger seat.
- You may not drive between the hours of 11:00 p.m. and 5:00 a.m. unless your spouse, guardian or parent who is a driver licensed in Pennsylvania and is at least 18 years of age is with you.
- You may not carry more passengers than seat belts available in the vehicle you are driving.

Junior Driver License Information

Like the junior learner's permit, there are some limitations to the junior driver's license. They are:

- You may not drive between the hours of 11:00 p.m. and 5:00 a.m. unless your spouse, guardian or parent who is a driver licensed in Pennsylvania and is at least 18 years of age is with you. *However, you may drive between 11:00 p.m. and 5:00 a.m. if you are involved in public or charitable service, a member of a volunteer fire company or employed during those hours. In these cases, you must carry a notarized affidavit or certificate of authorization from your employer, supervisor or fire chief indicating your probable schedule of activities. This notarized affidavit should be kept with your license.*
- You may not carry more passengers than seat belts available in the vehicle you are driving.
- You will receive a mandatory 90-day suspension if you accumulate six (6) or more points or are convicted of driving 26 miles per hour or more over the posted speed limit.
- You may get a regular license after you have held a junior license for one (1) year, if you meet the following conditions:
 - Have passed a driver training course approved by PennDOT,
 - have **not** been involved in a crash for which you are partially or fully responsible for one (1) year,
 - have **not** been convicted of any violation of the Pennsylvania Vehicle Code for one (1) year, and
 - have the consent of your parent, guardian, person in loco parentis or spouse who is at least 18 years of age.

If you meet these requirements you may apply for a regular license. Your junior license will automatically become a regular license when you turn 18 years of age.

What Class of License Do You Need?

In Pennsylvania, driver's licenses are issued specifically for the class and type of vehicle you operate. Therefore, the class of license you should have depends specifically upon the type of vehicle you operate. Generally speaking, the majority of applicants for a Pennsylvania driver's license will be operators of regular passenger vehicles, pick-up trucks or vans. **This manual is designed to provide the information you need to get a non-commercial Class C license, which is the class that covers these types of vehicles.**

Class of Licenses

CLASS A: Required to operate any combination of vehicles with a gross weight rating of 26,001 pounds or more, where the vehicle(s) being towed is/are in excess of 10,000 pounds. Example: Recreational vehicle when the towing vehicle is rated at 11,000 pounds and the vehicle towed is rated at 15,500 pounds (total combination weight of 26,500 pounds).

CLASS B: Required to operate any single vehicle rated in excess of 26,000 pounds. Example: Motor homes rated at 26,001 pounds or more.

CLASS C: A Class C driver's license will be issued to persons 16 years of age or older who have demonstrated their qualifications to operate any vehicles, except those requiring a Class M qualification, and who do not meet the definitions of Class A or Class B. Any firefighter or member of a rescue or emergency squad who is the holder of a Class C driver's license and who has a certificate of authorization from a fire chief or head of the rescue or emergency squad will be authorized to operate any fire or emergency vehicle registered to that fire department, rescue or emergency squad or municipality. The holder of a Class C driver's license is also authorized to drive a motorized pedalcycle (a motor-driven cycle) or a three-wheeled motorcycle equipped with an enclosed cab, but not a motorcycle.

CLASS M: A Class M driver's license will be issued to those persons 16 years of age or older who have demonstrated their ability to operate a motorcycle or motor-driven cycle. If a person is qualified to operate only a motorcycle or motor-driven cycle, he/she will be issued a Class M license. Please refer to the Pennsylvania Motorcycle Operator's Manual (Pub. 147). If your motorcycle is less than 50 CCs, a "V" restriction will appear on your license. This restriction prohibits you from operating a motorcycle 50 CCs or larger.

COMMERCIAL CLASS A, B, or C: Drivers who need a commercial driver's license should obtain the Commercial Driver License Manual (Pub. 223), which contains detailed information necessary to prepare for the tests.

TESTS

Knowledge Test

The Knowledge Test will measure your knowledge of traffic signs, Pennsylvania's driving laws and safe driving practices. The Knowledge Test can be given in oral form and in Spanish, upon request, at all Driver License Centers across the Commonwealth. If you fail the knowledge portion of the driver's test, you will be permitted to retake the test the following day. **This test needs to be successfully completed before you can receive a valid learner's permit.**

The Knowledge or Learner's Permit Test will consist of 18 multiple choice questions. You will need to answer 15 questions correctly to pass the test. A sample question is printed below.

In what state are you taking this exam?

1. Florida
2. Pennsylvania
3. Texas
4. California

Road Test

After you have received your valid learner's permit, you may go to any Driver License Center to take your Road Test **unless** you are under the age of 18. If you are under the age of 18, you must wait the mandatory 6 months from your permit issue date and have a signed Certificate of Completion for the 50 hours of skill-building before taking your Road Test.

Appointments **MUST** be made to take the Non-Commercial Skills Test in most cases. To make an appointment or to find out if one is necessary, call 1-800-932-4600 between the hours of 7:00 a.m. and 8:00 p.m., Monday through Friday, except holidays.

You will need to present the following items to the examiner prior to taking your Road Test. All items must be valid and for the correct vehicle.

- Your valid learner's permit.
- The completed certificate for 50 hours of behind-the-wheel training, if you are under the age of 18.
- The valid registration card for the vehicle you plan to drive for the test.
- Proof that the vehicle is currently insured.
- The valid driver's license of the person accompanying you to the Driver License Center.

If you do not bring the original documents (not copies) listed above, you will NOT be given the test.

Before the test begins, a driver license examiner will check to see that your vehicle has a valid registration card, current insurance, valid state inspection sticker and, if required, a valid emissions sticker. The lights, horn, brakes, windshield wipers, turn signals, mirrors, doors, seats and tires on your vehicle will also be checked to make certain that they operate properly and meet safety standards. If it is determined that any part of your vehicle is unsafe or does not meet state inspection requirements, you will not be allowed to take the Road Test. If your vehicle is equipped with safety belts, make sure they are clean and ready for use. You and the examiner will be required to wear them during the Road Test.

If your vehicle passes this inspection, the examiner will test you to see if you can drive safely.

You will fail the Road Test if you drive dangerously, violate the law, cause a crash, do not follow the examiner's instructions or make too many driving errors.

The examiner **MAY** ask you to do the following prior to taking the Road Test:

Vehicle Controls: Operate horn, lights (parking lights, high and low beam headlights, turn signals), windshield wipers, parking (emergency) brake, 4-way flashers (hazard lights), defroster, etc. Failure to properly operate any of the vehicle controls will result in a failure of your driving test.

Parallel Park: Park your vehicle midway between two (2) uprights 24 feet apart.

The examiner will be your only passenger during the Road Test. When the Road Test begins, you will be told where to drive and what maneuvers to make. **Close attention will be paid to the way you approach and obey warning signs, stop signs and traffic lights.** The examiner will note how you control your vehicle, use turn signals to communicate with other drivers or use any other vehicle controls that may become necessary during the test (refer to "Vehicle Controls").

If You Pass the Road Test

If you pass the Road Test, the examiner will endorse your learner's permit. You may drive with your endorsed learner's permit for 120 days.

You will receive your camera card at most Driver License Centers after passing the Road Test. If not, your camera card will be mailed to you within 45 days, along with a list of Photo License Centers where you may have your photo taken. This camera card is your temporary license and is valid for 60 days. Sign this card immediately and take it along with one of the forms of identification listed below containing your signature to the Photo License Center of your choice and have your photo taken. You will receive your photo driver's license at this time. After 60 days, your camera card can no longer be used as a temporary license but may still be taken to a Photo License Center to receive your photo driver's license.

Acceptable forms of identification at the Photo License Centers are:

- Pennsylvania Learner's Permit or a Temporary License issued by PennDOT
- Passport
- Certification of United States Citizenship
- Certification of Naturalization
- Expired Pennsylvania Photographic Driver's License
- Pennsylvania Photographic Identification Card
- Photographic Employee Identification Card
- Photographic Military Identification Card
- Weapons Permit
- Pennsylvania Vehicle Registration Card
- Pennsylvania Photographic Welfare Card
- Photographic Bank Identification Card
- Photographic School Identification Card
- Voter Registration Card
- Medicaid Card

If You Fail the Road Test

Below are some examples of possible reasons for failing the Road Test:

- Inability to operate any vehicle controls
- Violating any traffic laws (e.g., failing to obey a stop sign)
- Causing a crash
- Driving dangerously or recklessly
- Failing to wear your safety belt
- Making errors in safe driving practices
- Failing to follow instructions given by the examiner
- Not using turn signals when attempting to parallel park

If you are under the age of 18 and fail the Road Test, you will be required to wait seven (7) days before you can retake the Road Test. This delay in retaking the test will give you time to practice and to improve your driving skills. You have three (3) chances with each learner's permit to pass the Road Test before the permit's expiration date. After the third failure, you must reapply to extend your learner's permit.

If you do not pass your Road Test after three (3) tries or if your learner's permit expires, you may obtain an Application to Add/Extend/Replace/Change/Correct Non-Commercial Learner's Permit (Form DL-31). If you have not taken or successfully completed the Road Test within three (3) years of your physical examination date, you **MUST** start over with another Non-Commercial Learner's Permit Application and retake the Knowledge Test.

SIGNALS, SIGNS, AND PAVEMENT MARKINGS

This chapter will provide the information you need to know about Pennsylvania roadways. The areas addressed include:

- Signals
- Signs
- Pavement Markings

SIGNALS

Traffic signals are installed at intersections to control the movement of vehicles and pedestrians. Traffic signals are arranged in either vertical lines or horizontal lines. When they are arranged vertically, red is always on top and green on the bottom. When they are arranged horizontally, red is always on the left and green on the right.

Red, Yellow and Green Traffic Lights and Arrows

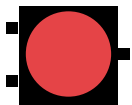

When a light is steady red, you must stop before crossing the marked stop line or crosswalk. If you do not see any lines, stop before entering the intersection. Wait for a green light before you start.

You may turn right while the light is red unless a “No Turn on Red” sign is posted at the intersection. You must first stop and yield to pedestrians and other traffic.

You may also turn left after you stop at a red light if you are in the left lane and are turning left from a one-way street onto another one-way street, unless a sign tells you not to turn. You must first stop and yield to pedestrians and other traffic.



A steady yellow light tells you that a red light will soon appear. If you are driving toward an intersection and a yellow light appears, slow down and prepare to stop. If you are within the intersection or cannot stop safely before entering the intersection, continue through carefully.



A green light means you may drive through the intersection if the road is clear. You may also turn right or left unless a sign tells you not to. However, when turning, you must yield to other vehicles and pedestrians within the intersection.



A green arrow means you may turn the way the arrow points. If the green arrow goes off and a circular green light follows, you may still turn in that direction, but first yield to pedestrians and vehicles.

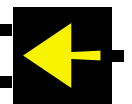

A yellow arrow means the movement permitted by the green arrow is about to end. You should slow down and prepare to stop completely before entering the intersection.



Although not common in Pennsylvania, a red arrow is frequently used in many other states. It means that you may not turn in the direction that the arrow points.

Flashing Signals



A flashing red light has the same meaning as a "STOP" sign. You must come to a complete stop, look and proceed only after the intersection is clear.

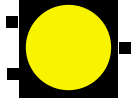

A flashing yellow light means caution. Slow down, look and proceed carefully.

Non-Functioning Traffic Lights

A non-functioning traffic signal should be treated as though it were a stop sign at a four-way intersection.

Lane Use Control Signals

Special signals may also be placed directly over traffic lanes to control traffic. These signals show how specific lanes of a street or highway should be used.



A steady downward green arrow over a traffic lane means you may use the lane.



A steady yellow "X" over a traffic lane means that you must change lanes. Get ready to leave the lane safely.



A steady red "X" over a lane means you are not allowed to use the traffic lane.



A flashing yellow "X" over a traffic lane means that you may use the lane only to make left turns.

Pedestrian Signals (Motorists Must Yield to Pedestrians)

Pedestrians must obey traffic and pedestrian signals. The pedestrian signals they must obey are the **WALK** and **DON'T WALK** lights, or the lighted picture of a **walking person** (meaning walk), and an **upraised hand** (meaning don't walk). If there are no pedestrian signals at the intersection, pedestrians must obey the red, yellow and green traffic lights.



Some pedestrian signals change the **WALK** and **DON'T WALK** lights automatically. Other pedestrian signals will not change unless you push the button.

In order to change the traffic signal from **DON'T WALK** to **WALK**, you have to push the pedestrian walk button to cross the street in the direction of the arrow.

**DONT
WALK**

When the steady **DON'T WALK** message or steady **upraised hand** is displayed, do not cross.

**DONT
WALK**

When the flashing **DON'T WALK** or flashing **upraised hand** begins:

- a. Finish crossing if you are in the street.
- b. **DO NOT START TO CROSS** if you have not left the curb.

WALK

When a steady or flashing **WALK** or **walking person** comes on, start crossing, but watch for turning vehicles.

Blind Pedestrians

When driving near a blind pedestrian who is carrying a white cane or walking with a guide dog, you must slow down, yield the right-of-way and proceed with caution. Be prepared to stop your vehicle in order to prevent injury or danger to the pedestrian.

Railroad Crossing Signal

Drivers are alerted when approaching a railroad crossing by the railroad crossing sign. Railroad crossings should be approached with caution at all times. Always look both ways and listen for any approaching trains or signals before proceeding across the railroad tracks.

You are also required to stop at all railroad crossings when there is a signal of an approaching train. These signals include flashing red lights, a crossing gate lowered, a flagger signaling or a train's audible signal of warning. **DO NOT** move forward or attempt to go around any gate or ignore any signal of an approaching train.

Proceed with caution only after all signals are completed and then only when there is evidence that no trains are approaching the crossing.

You should also stop if a train is approaching a crossing and has sounded its audible signal from approximately 1,500 feet before the crossing or is plainly visible and in hazardous proximity to the crossing.

If none of the above apply when you are at a railroad crossing, you should, at a minimum, **STOP**, look both ways and listen before crossing the tracks.

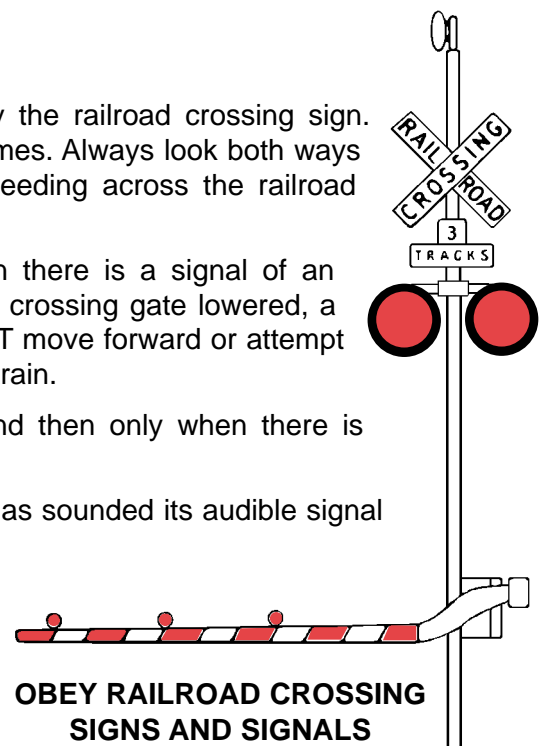

Do not stop your vehicle on a railroad track, regardless of whether or not a train appears to be coming. If traffic is backed up because of a traffic signal, stop sign, or for any other reason, make sure you stop your vehicle in a location where it will be entirely clear of any railroad tracks.

SIGNS

Signs are divided into three basic categories. Each has its own special shape. The three categories are Regulatory, Warning and Guide signs.

Regulatory Signs

Regulatory signs indicate what you may or may not do. They advise you about speed limits, the direction of traffic, turning restrictions, parking, etc.

Usually regulatory signs are vertical rectangles or squares, but **STOP** and **YIELD** signs are different.



The **STOP** sign is the only eight-sided or octagon-shaped sign you see on the highway. At an intersection with a **STOP** sign, you **MUST** stop and wait for pedestrians and cross traffic to clear the intersection before you go again. Slowing down without coming to a full stop is illegal.

When you see a crosswalk or a stop line, stop before the front of your car reaches the painted line. If you cannot see traffic, yield to any pedestrians, then carefully pull forward past the line until you can see clearly. Stop, check for traffic and pedestrians, then go ahead when the intersection is clear.

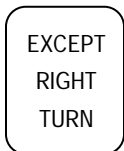

Used in conjunction with stop signs, this sign allows motorists to make the right turn without stopping.



A **FOUR-WAY STOP** sign means that there are four stop signs at this intersection. Traffic from all four directions must stop. The first vehicle to reach the intersection should move forward first. If two vehicles reach the intersection at the same time, the driver on the left yields to the driver on the right.



YIELD signs are triangular (3-sided) in shape. When you see this sign, you must slow down and check for traffic and give the right-of-way to pedestrians and approaching cross traffic. You stop only when it is necessary. Proceed when you can do so safely without interfering with normal traffic flow. Remember, you must have a sufficient gap in traffic before you can continue on at either **STOP** or **YIELD** sign locations.



This sign is used in conjunction with a yield sign at a one-lane bridge or underpass location to alert motorists that the one-lane roadway requires them to yield the right-of-way to opposing traffic.

The **DO NOT ENTER** and **WRONG WAY** signs work as a team. The **DO NOT ENTER** sign is put at the beginning of one-way streets and ramps. When you see this sign, do not drive onto that street.

WRONG WAY signs are placed farther down the ramp or one-way street. They are placed there to catch your attention if you accidentally turn onto the street or ramp.



This sign prohibits U-turns. Do not make a complete turn to go in the opposite direction.



This sign indicates that right turns are prohibited. Do not make a right turn at this intersection.

The following signs are located where certain actions or vehicles are prohibited at any or all times:



NO TRUCKS



NO BICYCLES



**NO PEDESTRIAN
CROSSING**



NO PARKING



This sign marks the beginning of a no passing zone. This sign is placed on the left side of the road facing the driver.



The **DO NOT PASS** sign may be placed in areas where passing any vehicles going in the same direction is prohibited.



This sign indicates that, at the intersection ahead, traffic in the left lane must turn left and traffic in the adjoining lane may turn left or continue straight.

These signs are over the lane they control to show that traffic may proceed through the intersection or turn in a particular direction.



TURN TO LEFT OR RIGHT



STRAIGHT OR TURN RIGHT



TURN RIGHT ONLY



TURN LEFT ONLY



CENTER LANE LEFT TURN ONLY signs indicate where a lane is reserved for the exclusive use of left turning vehicles in either direction and is not to be used for through traffic or passing.



This sign directs drivers to keep to the right of the traffic island or divider.



A **SPEED LIMIT** sign indicates the maximum legal speed for the stretch of highway where it is posted.



This sign marks areas where parking is reserved for disabled persons or severely disabled veterans. Vehicles parked in these spaces must display authorized registration plates or parking placards. Unauthorized vehicles parked in these spaces are subject to a fine and towing costs.



You may not turn right or left during the red light where these signs are posted. You must wait for the signal to turn green.



These signs indicate that a left turn is permitted, but you must yield to oncoming traffic.



These signs are posted where opposing traffic may continue to move after your signal has turned red.

Warning Signs

Warning signs tell you what to expect ahead. They warn you about conditions on or near the roadway. They are posted before the condition, so you can be prepared. Warning signs are usually diamond shaped with black symbols or messages on yellow backgrounds.



CHEVRON SIGN. A sharp curve in the road in the direction of the arrow.



RIGHT CURVE. Maintain a safe speed and keep to the right of your lane. The road will curve sharply to the right.



LEFT CURVE. Maintain a safe speed and keep well to the right of your lane. The road will curve sharply to the left.

SERIES OF CURVES. Several curves are ahead. Drive slowly and carefully.



ROAD ENTERING CURVE. The main road curves to the left with a side road entering from the right.



This sign identifies curves where trucks traveling at excessive speed have a potential to rollover.



ADVISORY SPEED SIGN. The highest speed you should travel around the curve ahead is 35 miles per hour. Advisory speed signs may be used with any diamond-shaped warning sign.



MERGING TRAFFIC. Traffic may be merging into your lane from another roadway.



TWO-WAY TRAFFIC AHEAD. The one-way street or roadway ahead ends. You will then be facing oncoming traffic.



DIVIDED HIGHWAY AHEAD. The highway ahead is divided into two one-way roadways. Keep to the right.



DIVIDED HIGHWAY ENDS. The divided highway on which you are traveling ends ahead. You will then be on a roadway with two-way traffic. Keep to the right.



LANE ENDS. In this example, traffic in the right lane must merge left. Drivers in the left lane should allow others to merge smoothly.

The signs below show types of intersections. They warn you about possible problems with crossing vehicles, turning vehicles, or vehicles traveling your way that may be turning. Watch out for these problems whenever you approach intersections.



CROSS ROAD



SIDE ROAD



“T”
INTERSECTION



“Y”
INTERSECTION



NARROW BRIDGE OR UNDERPASS AHEAD.



SLIPPERY WHEN WET. In wet weather, reduce your speed. Do not speed up or brake quickly. Make turns at a very slow speed.



LOW CLEARANCE. Do not enter if your vehicle is taller than the height listed on the sign.



HILL/DOWNGRADE. There is a steep hill ahead. Slow down and be ready to shift to a lower gear to control speed and save brakes.



TRAFFIC SIGNAL AHEAD. Traffic signals are present at intersection ahead. Slow down; the signal may not be immediately visible.



STOP SIGN AHEAD. Slow down; the stop sign may not be immediately visible.



BICYCLE CROSSING AHEAD.



PEDESTRIAN CROSSING. Used at or in advance of marked crosswalks to warn you that pedestrians may be crossing.



SCHOOL. You are near a school zone. Watch for children.



SCHOOL CROSSING. Slow down; you are near a marked crossing. Watch for children crossing the road. Stop if necessary. Obey signals from any crossing guards.



RAILROAD CROSSING.



BICYCLE/MOTOR VEHICLE SHARE THE ROAD. Used at roadway pinch points (no shoulder, narrow lanes, etc.) to warn you, as a motorist, to provide adequate space for bicyclists to share the roadway.



This sign is posted in areas where slow moving horse-drawn vehicles cross or share the roadway with motorized vehicles.

Objects Adjacent to the Roadway

Objects not actually in the roadway may be so close to the edge of the road that they need a marker to warn the driver of a potential danger. These include underpass supports, ends of bridges, handrails, and the concrete structure found at the end of a pipe. In some cases, there may not be a physical object involved, but rather a roadside condition such as drop-offs or abrupt changes in the roadway alignment that also create a potentially dangerous condition for the driver. Such roadside objects and conditions are indicated by the following markers:



HAZARD IS TO THE LEFT



HAZARD IS TO THE RIGHT

Work Zone Signs

Work Zone Signs are normally shaped like warning signs, but they are black and orange. These signs are used only near maintenance, construction or utility areas. They are placed on or near the roadway. Stay alert and slow down when you see these signs.



Road work ahead.



Right lane will be closed 1,000 feet ahead.



A flagger will be controlling traffic.

Electronic Arrow Panels

Large electronic flashing arrow panels placed in the roadway or mounted on vehicles advise approaching motorists of lane closures. Begin your merge well in advance of the sign.

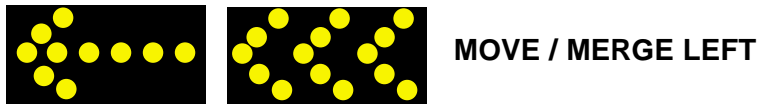

An arrow panel displaying either of the following messages indicates there is a work area ahead adjacent to the travel lane and to drive with extra caution.

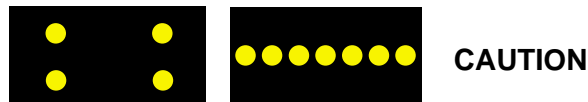

May be used in work areas to advise motorists that fines for moving violations committed within the work area WILL BE DOUBLED.

Flagger Ahead

When approaching a work zone, pay special attention to flaggers who may signal you to stop or slow down. As shown below, they use a STOP and SLOW paddle:

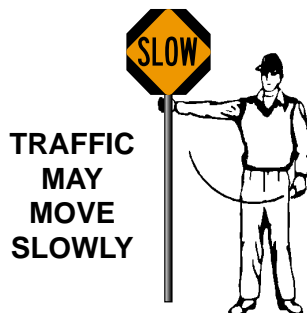

Guide Signs

Guide signs give information on intersecting roads, help direct you to cities and towns, and show points of interest along the highway. Guide signs also help you find hospitals, service stations, restaurants and motels. Usually these signs are horizontal rectangles.

Freeway / Expressway Guide Signs

The following three signs are examples of freeway and expressway guide signs. They are green with white letters. Most freeway and expressway signs are posted the same way. For example, there is usually one advance sign which is followed by another advance sign. The third sign then is posted at the exit. Several signs are necessary because the high speed and heavy traffic on highways can cause drivers to miss seeing a single sign. Also, motorists may need to make one or more lane changes to exit.

Note: If the exit sign is located on the top right of the guide sign, the exit will be on the right side of the highway. If the exit sign is located on the top left of the sign, the exit will be on the left side of the highway.



If a yellow panel with the message “EXIT ONLY” is on a freeway sign, the lane below the sign will not continue through the interchange. Instead, the lane will go off the road to form a ramp. If you are in a lane posted with an “EXIT ONLY” sign but do not wish to exit, change lanes, or you will be forced to exit.

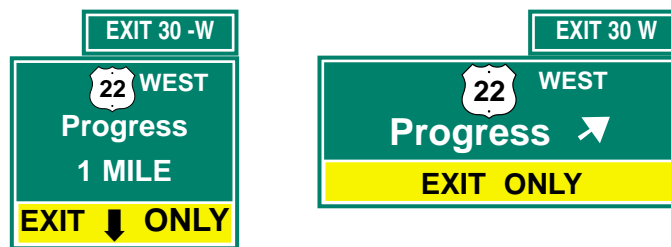

Signs showing street names are among the smallest guide signs. In many municipalities, you can find your way by reading street name signs. Colors and styles of these signs will vary.



Service Signs

The following signs are examples of service signs. They are square or rectangular and are blue with white letters or symbols. They show the location of various services.



HOSPITAL



TELEPHONE



FOOD



GAS



LODGING

Tourist-Oriented Directional Signs



These signs are square or rectangular and may also be green or brown with white lettering. They direct motorists to tourist attractions such as museums, historical landmarks or state or national parks.

Interstate Route Numbering System



The routes are specially numbered to help motorists find their way through unfamiliar areas. A code is used to show if the route travels east and west, or north and south, and to show if the route is in the eastern, middle or western United States.

The red, white, and blue shield sign shows that the highway is an Interstate traffic route.

Decoding the Interstate Route Numbering System

The numbers on the Interstate shield can be a great navigational aid when you understand how they are developed. They generally follow the pattern below:

- One or two-digit **even**-numbered Interstates are generally east-west routes. Nationally, the numbers increase from I-10 in the south to I-94 in the north. In Pennsylvania, Route I-76 is in the southern part of the state and Routes I-84 and I-80 are in the northern part.
- One or two-digit **odd**-numbered Interstates are generally north-south routes. Numbers increase from the west coast I-5 to the east coast I-95. In Pennsylvania, I-79 is in the western part of the state, and I-95 is in the eastern area.
- Three-digit numbered Interstate highways connect to other major highways. If the first of the three digits is an **even** number, the highway usually connects to Interstate highways at both ends, such as I-276 in Philadelphia. Many times such routes are known as “loops” or “beltways.”
- When the first of the three digits is an **odd** number, the highway is usually a “spur” route that connects with another Interstate at only one end, sometimes going into a city center such as I-180 in Williamsport.

Route Markers

The following signs indicate the route on which you are traveling.



The route marker shows that the road is a U.S. traffic route.



The keystone marker shows that the road is a Pennsylvania traffic route.



The junction plate shows that you are approaching the intersection of U.S. Route 22.



The route marker shows that you are traveling west on U.S. 22.



This supplemental arrow on the route marker assembly means you are approaching a right turn to continue on U.S. 22 West.



The route marker sign and "TO" trailblazer sign and the supplemental arrow means that if you want to gain access to U.S. 22, you must continue ahead.



Mile Markers



"Mile Markers" indicate the number of miles from the point where the Interstate route entered the state, starting at zero in the western part of the state for east-west roadways and in the southern part of the state for north-south roadways. The numbers increase as you travel east or north and decrease as you travel west or south. For example, when you enter Pennsylvania from the west on Route I-80, the mile markers begin at "Mile 1" and increase as you travel east. Knowing how to read mile markers can help you to know exactly where you are and give an approximate location if you have to call for roadside assistance.

PAVEMENT MARKINGS

Most roads have permanent markings to show the center of the road, travel lanes or road edges. These pavement markings also indicate special lane use.

Yellow lines divide traffic traveling in opposite directions. White lines divide lanes of traffic traveling in the same direction. As a general rule, broken traffic lines can be crossed and solid lines cannot, except when making a turn. Some examples of different pavement markings and their meanings follow:

A single broken yellow centerline shows the center of a two-way, two-lane road. Passing is permitted on either side if safe conditions exist.

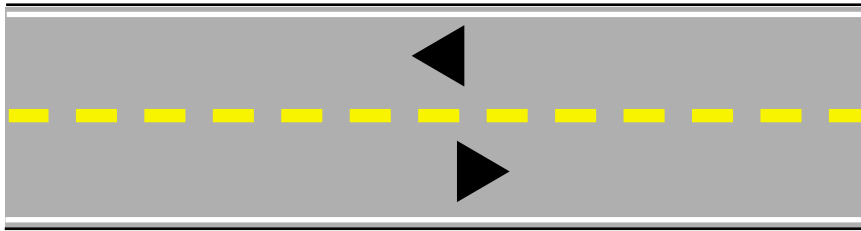

A double solid yellow centerline shows the center of a two-way road. Even if it is not marked "NO PASSING," passing by traffic traveling in either direction is not allowed on roads marked in this manner.

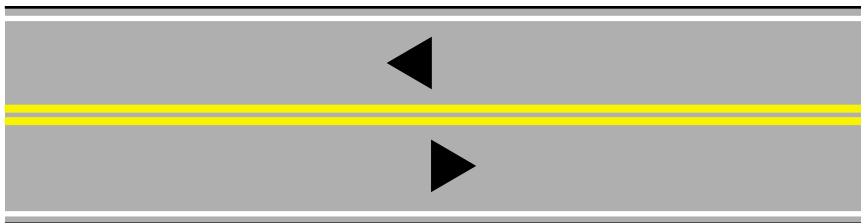

The combination of a solid yellow and a broken yellow centerline also shows the center of a two-way roadway. You may pass if the broken line is on your side of the road and safe conditions exist, but you may not pass when a solid yellow line is on your side of the road.

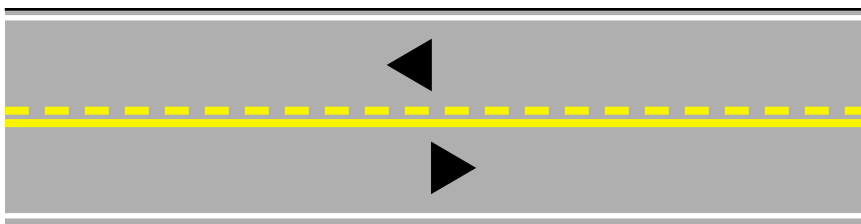

Marking patterns like the ones shown below may be found on many three-lane highways. The solid yellow centerline means you cannot use the center lane for passing. The broken yellow centerlines show that vehicles traveling in either direction may use the center lane only to make left turns.

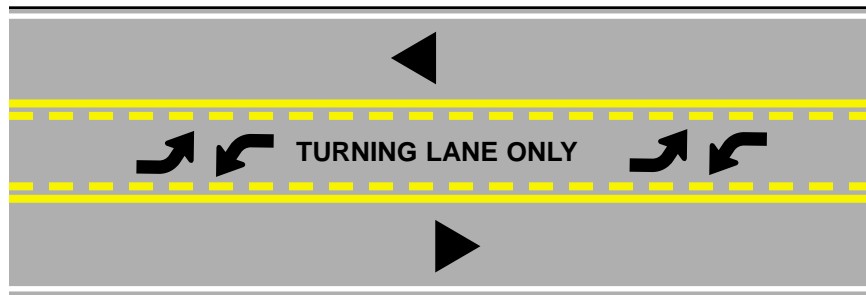

Multi-lane highways without medians (center dividers) are often marked as pictured below. Broken white lines show which lanes can be used by vehicles traveling the same way. You may cross the broken white lines to pass, but you may not cross the double yellow centerlines to pass. The lane to the left of the yellow centerline is for traffic traveling in the opposite direction.

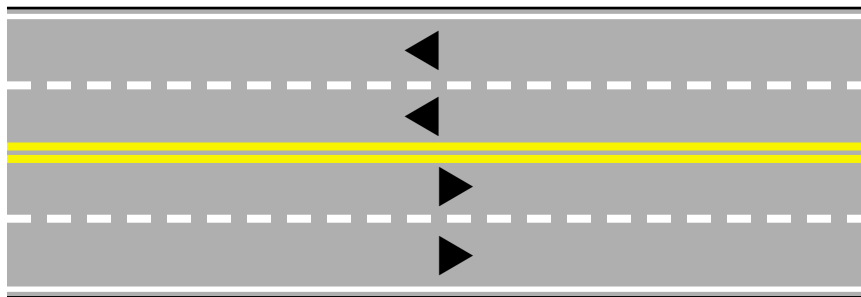

The pattern shown below is used on most limited access highways with medians (center dividers). The right edge of the road is marked with a solid white line. The left edge of each side is marked by a solid yellow line. The traffic lanes for each side are marked by white broken lines, which may be crossed.

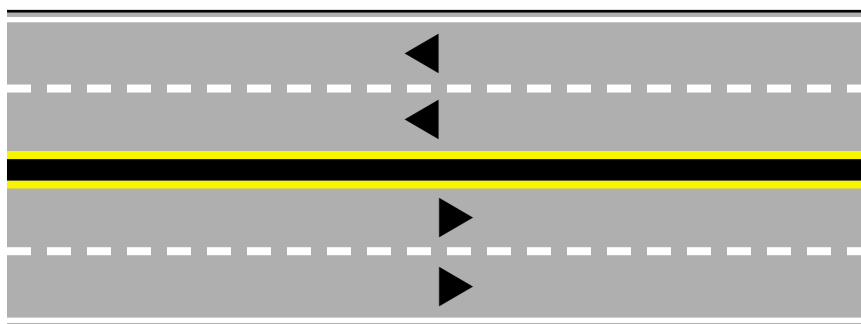

LEARNING TO DRIVE

This chapter will provide most of the information you will need to become a safe driver. Becoming a safe driver involves developing your driving skills while adapting to the environment around you. The areas addressed include:

- Vehicle Safety and Emissions Inspection
- Preparing to Drive
- Developing Your Driving Skills
- Adjusting Speed
- Special Circumstances
- Emergency Driving Skills
- Keeping in Shape for Driving
- Trip Planning

VEHICLE SAFETY AND EMISSIONS INSPECTION

Your vehicle must have a safety inspection, performed at an authorized inspection station, every 12 months. The number on the sticker indicates the date when your vehicle must be inspected again. Vehicles may be inspected up to 90 days before their inspection expiration date.

Drivers are required to maintain their car in a safe condition. If faulty equipment is noticed by a police officer, the driver could be warned to repair the problem within five days or risk a citation.

The emissions inspection program covers all gasoline-powered, model year 1975 or newer cars, vans and light-duty trucks weighing 9,000 pounds or less. Inspections are performed at privately owned garages and service stations certified by PennDOT. Inspection fees can vary. You must get your vehicle's emissions inspection before you can complete your safety inspection.

To find out if vehicles in your county are subject to emissions inspection or to obtain more information about the emissions program, call the emissions customer hotline at 1-800-265-0921.

PREPARING TO DRIVE

It is important that you take a few moments to prepare yourself to drive. Here are a few important things you should do before you start the vehicle:

Adjust the Driver's Seat

Find the control for adjusting the driver's seat and adjust your seat so you can easily reach the pedals and other controls. In your owner's manual, you can find information telling you how to adjust your car's equipment. If the seat is too low, use a seat cushion.

Fasten your Seat Belt

Everyone should buckle up with both lap AND shoulder belts on every trip. The seat belt should be worn low and snug on the hips and tight across the shoulder. When airbags are in the vehicle, driver and front passenger seats should be moved as far back as practical. In Pennsylvania, front seat passengers are required by law to be buckled up. If you are under 18 years of age, you may only carry as many passengers as seat belts in your vehicle. Children 12 and under should ride buckled up in the rear seat. (See Chapter V for additional information on Child Restraint Laws.)

Adjust the Rearview and Side Mirrors

The rearview and side mirrors may have to be adjusted differently for each driver. The rearview mirror should be set so you can see the traffic directly behind your car. The side mirror(s) should be set so that when you lean left/right slightly you can see just the side of your vehicle. Set the mirrors after you adjust your seat. Properly adjusted mirrors remove most “blind spots” (spots beside or behind your vehicle where you cannot see other vehicles or pedestrians). This is especially important because of hard-to-see vehicles, such as motorcycles and small vehicles.

Adjust Ventilation

You should adjust the vents, windows and air conditioner, if applicable, to provide a constant supply of fresh air in the vehicle. This helps you stay alert and reduces the effects of any exhaust gas that may get into the vehicle.

Adjust Headrests

If properly adjusted, headrests can prevent or reduce the severity of neck injuries in a crash. If possible, adjust your headrest so it cushions the back of your head. Check your owner's manual for instructions.

Wear your Prescription Glasses/Contact Lenses

If you normally wear prescription eye glasses or contact lenses, always wear them while driving. Do not wear sun glasses or tinted contact lenses at night as they reduce available light and make it harder to see.

Using the Clutch

If your vehicle has a manual transmission, hold the clutch pedal down all the way with the gear shift in neutral when starting your vehicle. Engage the clutch when you shift gears. Do not ride with your foot resting on the clutch pedal. Do not coast to a stop with your clutch pedal depressed unnecessarily.

Checking Your Vehicle

The table provides a list of checks you can perform on your vehicle. You should also read the owner's manual that comes with the vehicle. In addition, to be ready for an emergency, make sure your spare tire is inflated and that you have a first-aid kit, a jack and flares in the trunk.

THE VEHICLE PART	WHY CHECK	WHAT TO CHECK	WHEN TO CHECK
Headlights	<ul style="list-style-type: none"> • Dirty lenses can cut your night vision by more than half. • Even with good lights, at 50 mph, you can see only about four seconds ahead. • A dead headlight may keep you from seeing a stalled vehicle or a sharp curve in time. • An out-of-line light can shine where it does not help you and may blind other drivers. 	<p>Driver Checks</p> <ul style="list-style-type: none"> • Burned out bulbs • Dirty lenses <p>Mechanic Checks</p> <ul style="list-style-type: none"> • Where lights shine 	<p>Driver Checks</p> <ul style="list-style-type: none"> • When you fill up with gas • After driving on wet or muddy roads • During snow or icy conditions • At least twice a year
Brake and Signal Lights	<ul style="list-style-type: none"> • Brake lights tell others that you are slowing down or stopping. • Signals tell others what you are about to do. 	<p>Driver Checks</p> <ul style="list-style-type: none"> • Burned out bulbs <p>Mechanic Checks</p> <ul style="list-style-type: none"> • Wiring and sockets 	<p>Driver Checks</p> <ul style="list-style-type: none"> • When you fill up with gas <p>Mechanic Checks</p> <ul style="list-style-type: none"> • At least once a year
Windows and Windshields	<ul style="list-style-type: none"> • Dirty windshields make it hard to see. • Scratched, cracked, or dirty glass can increase glare and make it hard to see. • Damaged glass can break even in a minor collision. 	<p>Driver Checks</p> <ul style="list-style-type: none"> • All glass inside and out to make sure it is clean • Scratches and cracks to see if glass needs to be replaced 	<p>Driver Checks</p> <ul style="list-style-type: none"> • When you fill up with gas • Every time you drive

THE VEHICLE PART	WHY CHECK	WHAT TO CHECK	WHEN TO CHECK
Tires	<ul style="list-style-type: none"> • Worn or bald tires increase your stopping distance. • Worn or bald tires lessen overall control. • Unbalanced tires and low pressure can cause tread wear. • Unbalanced tires cause the steering wheel to shake. • Low air pressure cuts down on gas mileage. • Worn tread is also one of the causes of “hydroplaning.” • You may have a blowout. 	<p>Driver Checks</p> <ul style="list-style-type: none"> • The air pressure when tires are cold (check owner’s manual) • Tread wear (<i>stick a Lincoln penny into the tread “head” first. If the tread does not come at least to Lincoln’s head, the tire is unsafe</i>) <p>Mechanic Checks</p> <ul style="list-style-type: none"> • Tire balance and damage 	<p>Driver Checks</p> <ul style="list-style-type: none"> • Once a week <p>Mechanic Checks</p> <ul style="list-style-type: none"> • At least once a year
Brakes	<ul style="list-style-type: none"> • They may not stop you fast enough to avoid a crash. • They may pull the vehicle to the side when stopping. • Failure to fix brakes is unsafe and can lead to more costly repairs. • If you repair brakes when a problem first appears, it saves costly repairs later. 	<p>Driver Checks</p> <ul style="list-style-type: none"> • Pedal pressure (<i>pedal when pushed should stay well above the floor</i>) • Vehicle pulling to the side when brakes are used • Scraping and squealing noise <p>Mechanic Checks</p> <ul style="list-style-type: none"> • Brake lining wear and fluid leaks 	<p>Driver Checks</p> <ul style="list-style-type: none"> • When you fill up with gas • Every time you drive
Steering	<ul style="list-style-type: none"> • Vehicle may be hard to turn. • Vehicle may not turn when the steering wheel is first turned. • It can take more time to avoid an emergency. 	<p>Driver Checks</p> <ul style="list-style-type: none"> • Steering wheel play (If the steering wheel moves two inches or more without moving the vehicle, it has too much play) 	<p>Driver Checks</p> <ul style="list-style-type: none"> • Every time you drive <p>Mechanic Checks</p> <ul style="list-style-type: none"> • When driver thinks something is wrong • At least once a year
Suspension (continued on next page)	<ul style="list-style-type: none"> • Vehicle may not hold the road on turns. • Ride will be uncomfortable over bumps. 	<p>Driver Checks</p> <ul style="list-style-type: none"> • Shocks (Push down hard on the front and rear of the vehicle. If the vehicle 	<p>Driver Checks</p> <ul style="list-style-type: none"> • When vehicle seems to bounce too much, or you

THE VEHICLE PART	WHY CHECK	WHAT TO CHECK	WHEN TO CHECK
Suspension	<ul style="list-style-type: none"> It can cause tires and other parts to wear out. 	bounces more than twice before stopping, you need new shocks) Mechanic Checks <ul style="list-style-type: none"> Shocks Springs 	<ul style="list-style-type: none"> have trouble controlling the vehicle After the winter season Mechanic Checks <ul style="list-style-type: none"> Every 20,000 miles or as recommended in your owner's manual
Exhaust	<ul style="list-style-type: none"> Fumes from leaky exhaust can cause death in a very short time. Never run the motor in your garage or sit in a parked vehicle with the motor running without opening a window. Worn-out exhaust parts increase the chance of the vehicle catching on fire. 	Driver Checks <ul style="list-style-type: none"> Any loud noises or rattles Signs of rust or holes in the muffler and tailpipe Mechanic Checks <ul style="list-style-type: none"> Leakage, wear and loose mountings 	Driver Checks <ul style="list-style-type: none"> Every time you drive Before and after the winter season
Windshield Wipers	<ul style="list-style-type: none"> Poor wiper blades will not clean the water off. They also skip places and leave streaks. A dirty windshield makes it harder to see. Poor wiper blades can scratch the windshield causing glare. 	Driver Checks <ul style="list-style-type: none"> Wiper blades for wear and tension on the glass Rubber on the blades, which can pull off in cold weather Windshield wiper fluid for cleaning windshield 	Driver Checks <ul style="list-style-type: none"> Several times a year Frequently in cold weather
Engine/ Tune-Up	<ul style="list-style-type: none"> Vehicle may lose power that is needed for normal driving and emergencies. Poorly tuned engines do not get good gas mileage. Engine may not start. Poorly maintained engines or inoperative emission controls decrease gas mileage and contribute to air pollution problems. 	Driver Checks <ul style="list-style-type: none"> Signs of less power (lugging) Hard starting Gas mileage (It should not be allowed to drop more than two miles per gallon) Mechanic Checks <ul style="list-style-type: none"> Points, plugs and condenser Wiring and timing Fuel system. 	Driver Checks <ul style="list-style-type: none"> Several times a year Frequently in cold weather

DEVELOPING YOUR DRIVING SKILLS

Keeping a Space Cushion Around Your Vehicle

If another driver near you makes a mistake, you will need time to react. The only way to be sure you will have enough time to react is to leave plenty of space between your vehicle and the vehicles around you. Try to keep a cushion of space on all sides of your vehicle.

Keeping a Cushion Ahead

Speeding and tailgating can be a deadly combination. Tailgating is a major cause of crashes. If you are following too closely and the vehicle ahead stops or slows suddenly, you may not be able to stop in time. How can you learn to follow safely? The “Four-Second Rule” is a helpful guide.

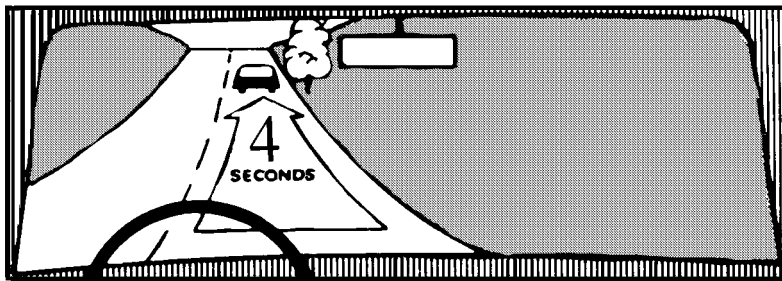

To follow the “**FOUR-SECOND RULE**” watch the rear bumper of the vehicle ahead. When the bumper passes a shadow or road marking, start counting the seconds you take to reach the same spot on the road. If you pass the shadow or road marking in less than four seconds, you are following too closely.

Sometimes you need an extra cushion of space. Allow a longer following distance when:

- Traveling on slippery roads.
- Following motorcycles or bicycles. If the cycle falls, you will need extra room to avoid the rider. The chances of a fall are greatest on wet roads, on metal surfaces (e.g., bridge gratings or streetcar tracks) and on gravel.
- The driver behind you wants to pass. Keep a steady speed while being passed. Leave room in front of your vehicle to help the driver pass.
- Following drivers whose rear view is blocked. The drivers of trucks, buses, vans or cars pulling campers or trailers cannot see you very well. They could slow down suddenly without knowing you are behind them.
- Following large vehicles that block your view ahead. You need extra room to see around the vehicle and to the sides.
- Carrying a heavy load or pulling a trailer. The extra weight will make it more difficult to stop.
- Driving at high speeds.
- Approaching slow moving vehicles, including bicycles.
- Following school buses, taxis, public and private buses and trucks transporting hazardous substances. These vehicles must stop at railroad crossings. Expect these stops, and slow down early to allow plenty of room.
- Stopping on a hill. The vehicle ahead may roll back into your vehicle when it starts.

Keeping a Space Cushion to the Sides

A space cushion to the sides will give you room to react if other vehicles suddenly move toward your lane. To help avoid crashes, remember these points:

- Avoid driving alongside other vehicles on multi-lane streets. If possible, move ahead of the other vehicles or drop back.
- Keep as much space as possible between you and oncoming vehicles.
- Make room for vehicles entering freeways. If there is no one next to you, signal, check traffic and move to an inside lane.
- Keep space between you and parked vehicles. Someone may open a vehicle door or step out between parked vehicles, or a vehicle may pull out suddenly.

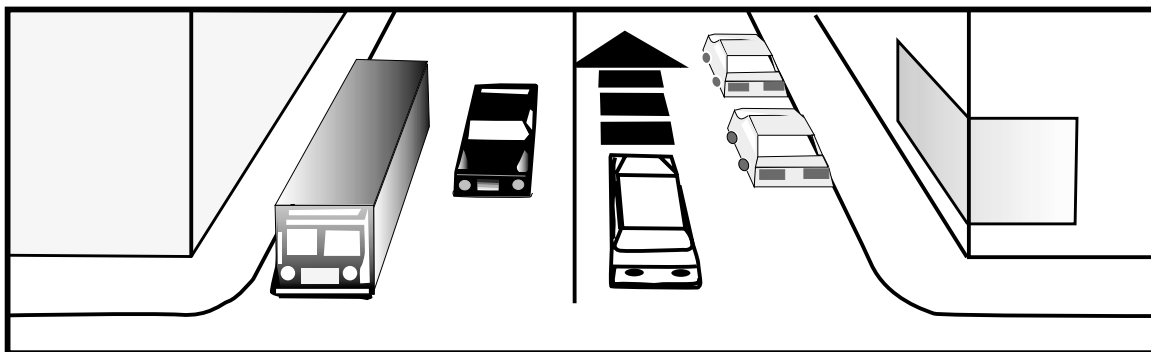

Sometimes you will find dangers on both sides of the road. For example, there may be parked vehicles to your right and oncoming vehicles to your left. In this case, the best thing to do is to slow down and “split the difference.” Splitting the difference means steering a middle course between the oncoming vehicles and the parked vehicles.

Keeping a Space Cushion Behind

The driver behind you has more control over the clear space behind you than you do, but you can help a driver behind you to keep a safe distance. Keep a steady speed and signal before you have to slow down.

Sometimes you may see a vehicle following you too closely (tailgating). When this happens, move over to the right lane, if possible. If there is no right lane, wait until the road ahead is clear. You should then flash your brake lights and reduce your speed slowly. This will encourage the tailgater to drive around you.

Allowing a Space Cushion for Special Circumstances

In certain situations, drivers need a lot of room. For example, a driver who cannot see you may enter your path without knowing you are there. People who may have trouble seeing you include:

- Drivers at intersections or driveways whose view is blocked by buildings, trees or by other vehicles.
- Drivers whose windows are covered with snow or ice
- Drivers who are temporarily blinded by glare.
- Drivers backing out of driveways or parking spaces.

Even when others can see you, allow extra room if you think a driver may be distracted. To help these drivers see you, use your horn, lights, brakes or all three. People who may be distracted include:

- Delivery persons.
- Road construction workers.
- People who may be lost or confused on an unfamiliar road. A lost or confused driver is likely to make a move without looking for other traffic. This can happen at complicated intersections where the driver may change lanes suddenly.
- A driver with a vehicle full of passengers.
- Children, who often run into the street without looking.

Handling Traffic Conditions One at a Time

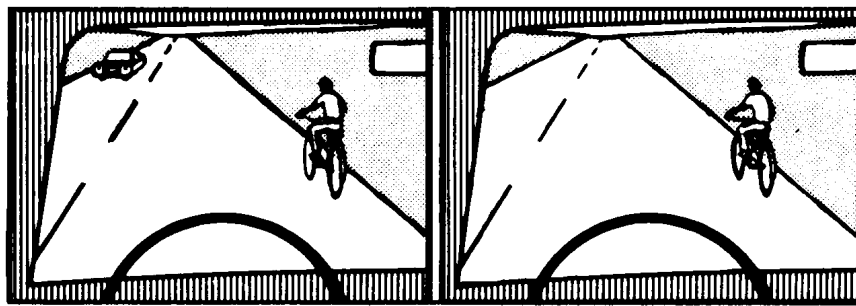

By thinking ahead, you can often face traffic conditions one at a time. Suppose there is only one oncoming vehicle to the left and a person on a bike to the right. Instead of driving between the vehicle and the bicyclist, face them one at a time. Slow down and let the vehicle pass. Then move far to the left before you pass the bicyclist.

Keeping Your Vehicle Where It Can Be Seen

Keep your vehicle where it can be seen. You cannot always be sure other drivers will see you, but you can avoid driving your vehicle where it cannot be seen. One common mistake is to drive in another driver's blind spot. Here are some good rules to help you avoid this mistake:

- A blind spot is any place around a vehicle that a driver cannot see without moving his/her head. Either speed up or drop back to clear the lane if you are in another driver's blind spot.
- Try to avoid driving on either side and slightly to the rear of another vehicle for a long time. Both positions are blind spots for the other driver.
- When passing another vehicle, get past the other driver's blind spots as quickly and as safely as you can. The longer you stay in a driver's blind spot, the longer you both are in danger.

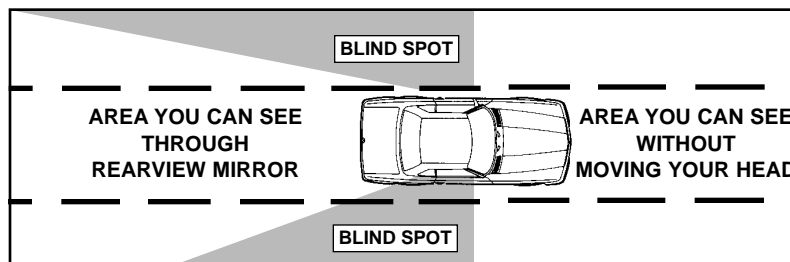

Seeing Clearly

To drive well, you must see clearly and react to what you see. To see clearly, you must know where to look. Make sure you know what is ahead of you, on both sides of you and behind you. Your windshield, other windows and side mirrors should always be clear. Use your headlights and defroster as needed.

Looking Ahead

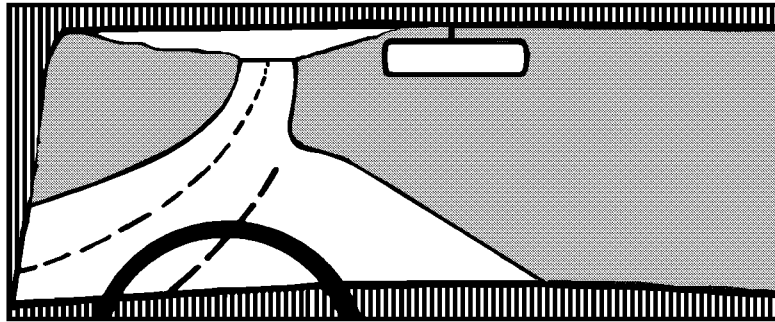

The driver in the picture is near the end of a lane. If this driver does not change lanes soon, the driver may have to make a quick lane change or stop and wait for traffic to clear. To avoid last minute moves, a driver must look far enough ahead to see and react to things early.

But looking ahead does not mean looking at the middle of the road. It means seeing the whole scene, including the side of the road. “**SCANNING**” the roadside helps you see:

- Vehicles and people that may be in the road by the time you reach them.
- Signs warning of danger ahead.
- Signs telling you about places ahead and how to reach them.

Looking to the Sides

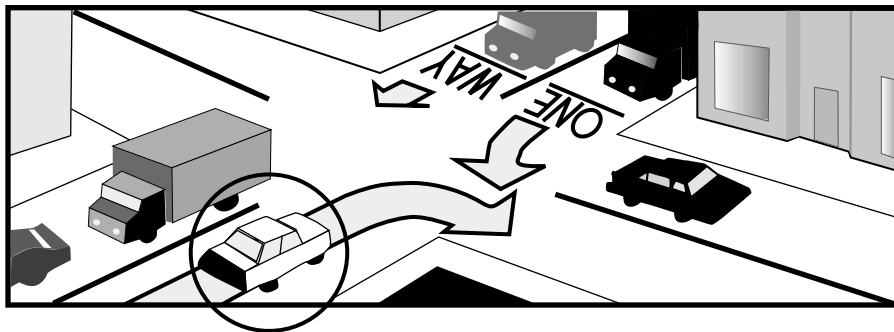

You should also know what is on both sides of you. At intersections or places where one lane of traffic meets another, look to the sides and make sure no vehicles or pedestrians are coming. This includes:

- Cross streets and side streets
- Freeway entrances and exits
- Driveway and shopping center entrances and exits.

When you come to an intersection, follow this important rule (left, right, left):

- Look to the left first because vehicles coming from the left are closer to you.
- Look to the right.
- Take one more look to the left before you pull out. That way you might see a vehicle you did not see the first time you looked.

When you enter the intersection, look left and right again. Someone at the cross street could make a mistake and miss a sign or signal. If your view of a cross street is blocked by a building or a row of parked vehicles, move forward slowly until you can see clearly.

Looking Behind

You must also check traffic behind you as often as possible. This is very important when you are planning to change lanes or back up. Changing lanes includes:

- Changing from one lane to another on a roadway
- Entering a freeway or highway from an entrance lane
- Entering the roadway from the curb or shoulder.

Changing Lanes

Before you change lanes, give the proper turn signal. Look in your rearview and side mirrors and make sure no one is going to pass you.

Also, look over your left and right shoulders to make sure no one is in your vehicle's blind spots. Check these spots quickly. Do not take your eyes off the road ahead for more than an instant.

Check all lanes before you change lanes on multi-lane highways. Someone in another lane may also be planning to move into the same spot where you want to go.

Backing Up

Be extra careful before you back up your vehicle. Check behind your vehicle before you get in. Children or small objects are hard to see from the driver's seat. Before backing, turn your head so you can see through the rear window. Do not depend on your mirrors alone. Back slowly because your vehicle is much harder to control when you are backing it up.

Driving at Night

Nighttime is the most dangerous time to be on the road. Most serious crashes occur in twilight or darkness, and traffic fatality rates are three to four times higher at night than in daylight.

All persons using the road, whether they are drivers or pedestrians, must take special precautions at night. You must drive more slowly and make every effort to stay alert. Some things (e.g., signs, road markings and other vehicles) are still easy to see because of lighting or reflectors. As a driver, you must be especially careful and expect that suddenly you may encounter something on the road ahead of you (e.g., pedestrians, bicyclists, animals or disabled vehicles).

Remember. . . the faster you are going, the less time you have to react to these potential dangers.

Using Your Headlights

Headlights have a dual purpose—to help you see and to help you BE SEEN. An easy way to increase visibility is to turn your headlights on during the day.

State law requires drivers to use their headlights:

- When they cannot see because of insufficient light on gray days or in heavy traffic when their vehicle may seem to blend in with the surroundings.
- When there are unfavorable atmospheric conditions including rain, snow, sleet, hail, fog, smoke or smog. Use only low beams because high beams actually reduce visibility in bad weather.
- When they cannot see pedestrians or vehicles on the highway for a distance of 1,000 feet ahead of the vehicle they are operating.
- Between sunset and sunrise.

State law calls for fines beginning at \$25 for drivers who fail to use their headlights when required!

Here are other tips on when to use your headlights:

- When it begins to get dark, turn your headlights on if you haven't already done so. This will help other drivers see you.
- When you are moving and lights are necessary, use your headlights, **NOT** just your parking lights. Parking lights alone do not help other drivers see you.
- Use your "low beam" setting during heavy fog, snow or heavy rain. Light from your "high beam" setting will reflect and cause glare. Use low beams as soon as you see another vehicle approaching in the oncoming lane as high beams can "**blind**" the other driver. Pennsylvania law requires that you use low beams whenever you are **within 500 feet** of an oncoming vehicle and when you are following a vehicle **within 300 feet**.

If a vehicle using high beams comes toward you, flash your lights quickly a few times. If the driver does not dim the lights, look toward the right side of the road. This will keep you from being "blinded" by the other vehicle's headlights and will allow you to see enough of the road's edge to stay on your course until the vehicle passes.

Do not try to punish the other driver by keeping your bright lights on. If you do, both of you may be "blinded." It is better if at least one of you can see well.

It is very important that you dim your high beams for oncoming bicyclists and pedestrians (especially runners). These road users may be blinded by high beams, and you expose them to grave danger if you don't dim your high beams.



You must also remember not to "**overdrive your headlights.**" This means that you should drive slowly enough that you could stop in time if any danger would appear on the length of road ahead that is lighted

by your headlights. Low beam headlights shine only about 250 feet ahead, and their beam is low and narrow. They do not shed much light on areas beside the road or on objects that are higher than the road surface. It is very difficult to see some hazards, like a pedestrian beside the road. Even in visible areas, you cannot see far enough to stop from 55 mph with low beam headlights. You should use your high beams as often as possible at night. High beam headlights shine up to 300 feet in front of your vehicle. You should drive below the speed limit when using low beams.

Communication

Crashes often happen because one driver does not see another driver, or one driver does something the other driver does not expect. It is important for drivers to **communicate**.

Communicating means letting others know where you are and what you plan to do. Do this by:

- Signaling when changing direction
- Signaling when slowing down or stopping
- Using your horn
- Using emergency signals.

Signaling When Changing Direction

Drivers expect you to continue traveling in the same direction. Let others know when you plan to do something different. Give them time to react to your moves. Use your turn signals before you:

- Change lanes
- Turn at an intersection
- Enter or leave a freeway
- Pull away from a curb
- Pull over to the side of a road.

Get into the habit of signaling every time you make a change. Bear in mind that turn signals **DO NOT** give you the right to make a turn. Signal even when you do not see anyone else around. **Under Pennsylvania law, you must always use your turn signals at least 100 feet before turning if you are driving less than 35 miles per hour. If you are driving 35 miles per hour or more, you must signal at least 300 feet before turning.**

If your vehicle's signals do not work, use hand or arm signals as follows. You should learn to recognize the signals since bicyclists are also required to use them.

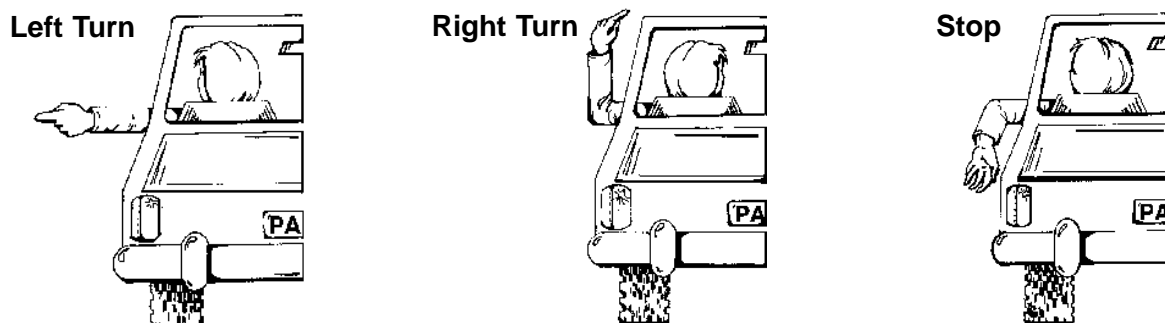

If you plan to turn after you pass an intersection, do not confuse other drivers by signaling too soon. They may think you are turning at the intersection and might pull into your path. On the other hand, if you signal

too late, the drivers behind you may not have enough time to react safely. In these cases, know the traffic conditions and use your best judgment.

After you have made a turn or lane change, make sure your turn signal is off. After some turns, the signal may not turn off by itself in which case you must turn it off manually.

Signaling When Slowing Down or Stopping

Your brake lights let people know that you are slowing down or stopping. If you are going to stop or slow down where other drivers do not expect it, quickly tap your brake pedal three or four times. For example, if you come over the top of a hill and you see a vehicle stalled on the road, tap your brakes to warn drivers behind you of the hazard.

If you must drive below 40 miles per hour on a limited access highway, use your emergency flashers to warn the drivers behind you. Also, if you are the last vehicle in a long line of slow or stopped traffic, use your four-way flashers to warn drivers following you.

Using Your Horn

Your vehicle's horn can get the attention of other drivers. Use it whenever you think another driver or pedestrian does not see you, but do not abuse it.

If you see a real danger, do not be afraid to honk your horn. For example, use your horn when a child is about to run into the street, when another vehicle is in danger of hitting you or if you have lost control of your vehicle.

But **NEVER** honk your horn at bicyclists. Horns may startle them and cause them to accidentally steer into your path. If you believe you must sound your horn when approaching a bicyclist, give the horn a quick tap from far away.

Using Emergency Signals

If your vehicle breaks down on the highway, make sure that other drivers can see it. Follow these rules if you have vehicle trouble along the road:

1. Pull off the road as far as possible.
2. Turn on your four-way flashers to show you are not moving.
3. Lift the hood as a sign of an emergency.
4. If you cannot get off the roadway completely, try to stop where people have a clear view of you and your vehicle from behind. Avoid stopping just over a hill or around a curve.
5. Give other drivers plenty of warning. Place emergency warning devices such as flares, flags or triangles about 100 feet in front of and behind the disabled vehicle. Place one on the traffic side of the vehicle too. This allows drivers to change lanes if necessary.
6. Stay off the roadway.

Wrong:

This driver has not only put flares too close to the vehicle but is also standing on the road.



Right:

This driver has placed flares far enough away from his vehicle, and he is waving oncoming traffic from the side of the road.



Turning

You must concentrate on many points when making a turn. Speed is probably the most important point. When turning, slow down to a speed that allows you to keep control in an emergency and to react to unexpected situations. You must be alert when turning. Watch out for pedestrians and for other traffic in the street where you are turning. Many streets have signs, signals or markings to guide you. Some signs show what lanes you can use for turns. To complete a turn safely, remember these four (4) steps:

1. Signal before your turn.
2. Position your vehicle in the proper lane.
3. Making the turn.
4. Complete your turn in the proper lane.

Signaling Before Turning - Before making any turn, you must signal first. Use your turn signal when turning onto another roadway or traffic lane or when leaving a parked position. Your signal lets other drivers know your plans. They can then adjust their driving so you can turn safely.

Positioning Your Vehicle - On two-lane, two-way streets or highways, make left turns from as close to the center line as possible. Right turns should be made from as close to the right edge of the roadway as possible.

To turn left on multi-lane streets and highways, start from the left lane. If you are turning right, start from the right lane.

Making the Turn - Speed is probably the most important point. When turning, slow down to a speed that allows you to keep control in an emergency and to react to unexpected situations.

You must be alert when turning. Even when making a turn on a green light, you must yield for pedestrians and for other traffic in the street where you are turning. Many streets have signs, signals or pavement markings to guide you. Some signs show what lanes you can use for turns.



If you see this sign above your lane, you may either drive straight or turn left at the upcoming intersection.



If you see this sign above your lane, you may either drive straight or turn right at the upcoming intersection.



If you see this sign above your lane, you may turn left or right. You cannot go straight.

Completing the Turn - If you are turning onto a highway which has more than one lane in the direction you wish to travel, turn into the closest lane going in that direction. For example, turn into the left lane when making a left turn. On a right turn, turn into the right lane. If you want to change to another lane, move only after you have finished your turn, traffic is clear and you properly signal your intent.

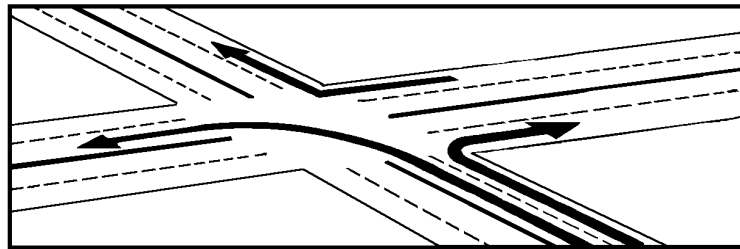

Sudden turns or lane changes cause crashes. So if you start through an intersection, keep going. If you start to make a turn, follow through. If you make a mistake, go on to the next intersection. You can always turn around and come back to where you want to go.



U-Turns - These are permitted only if they can be made without endangering other traffic. In choosing a place to make a U-turn, make sure that drivers coming from all directions are at least 500 feet away from you and that they have a clear view of your vehicle. Remember, U-turns are not allowed on a curve or when you are approaching or nearing the crest (top) of a hill. U-turns are also illegal at locations marked with this sign.



Turning at a Red Light - Unless you see this sign, you may turn right at a red light if traffic is clear. Before making the right turn, you must always stop first and yield to pedestrians and cross traffic.

If you are turning from a one-way street onto another one-way street, you may turn left on a red signal.

Driving in Traffic

This section reviews the skills you will need when driving through intersections, on highways and at their entrances and exit ramps. The actual physical skills are rather easy; however, the important judgments you must make require practice.

Moving with and through traffic requires skills obtained through knowledge and practice. You must drive in the lane nearest the right-hand edge of the road, except when overtaking another vehicle, or for a distance of up to two (2) miles in preparation for a left turn or as directed by official control devices, police officers or appropriately attired persons authorized to divert, control or regulate traffic.

Intersections

The law does not allow anyone the right-of-way. It only states who must yield. When a driver is legally required to yield the right-of-way but fails to do so, other drivers are required to stop or yield as necessary for safety. For example, a driver turning left must stop for a vehicle going through an intersection if stopping will prevent a crash. Never insist on having the right-of-way if doing so might cause a crash.

When no signs, symbols, or police tell you what to do, you must follow special laws. Here are six of these laws:

1. Drivers must yield to pedestrians under these conditions:
 - When pedestrians are crossing the roadway at an intersection without a traffic light (the crosswalk does not have to be marked).

- When pedestrians are crossing the roadway in marked crosswalks, whether or not at an intersection.
 - When the driver is turning a corner and pedestrians are crossing with the light.
 - When a blind pedestrian carrying a white cane or being led by a guide dog is crossing the street.
 - When pedestrians are crossing the sidewalk at a driveway or alley.
2. Drivers turning left must yield to oncoming vehicles going straight ahead.
 3. Drivers entering a traffic circle must yield the right-of-way to drivers already in the circle.
 4. When two vehicles approach or enter an intersection from different roadways at or about the same time, drivers coming from the left must yield to vehicles coming from the right.
 5. A vehicle entering a public highway from an alley, private road, or driveway must STOP and wait until the main road is clear.
 6. At a four-way stop, all vehicles must stop. The first vehicle stopping at the intersection should move forward first. If two vehicles reach the intersection at the same time, the driver on the left yields to the driver on the right.

Crossing, Merging and Leaving Traffic

Moving with and through traffic takes skills that come only through practice. The actual physical skills are rather easy, but the important judgments you must make require practice. You will use judgment skills to determine how much space you need to cross, merge and leave traffic, which are explained as follows:

Crossing Traffic - Whenever you cross traffic, you need enough space to do it safely. The space you need depends on your speed, the amount and speed of other traffic, and road and weather conditions.

Drivers proceeding straight do not expect to be stopped or slowed down by vehicles crossing or entering. So, when you cross traffic, make sure you can cross safely without slowing down other drivers. Remember these points when crossing traffic:

- Stopping halfway across a street is safe only when there is a turning lane provided in the center median that can hold your entire vehicle.
- If you are crossing or turning, make sure there are no vehicles or people blocking your path. You do not want to be caught in an intersection with traffic coming toward you.
- Even if you have a green light, do not enter an intersection if there are vehicles blocking your way. Also, do not get caught in an intersection when the light changes. You will block other traffic.
- Never assume that another driver will share space with you when you are turning. If an approaching vehicle has a turn signal on, do not guess that the driver will turn at the nearest street. The driver may plan to turn just beyond you, or the signal may have been left on from an earlier turn. This is especially true of motorcycles. Their signals do not turn themselves off. Wait until the other driver actually starts to turn before you go.
- Use special caution when crossing traffic in areas with hills or curves. You cannot see or be seen as well at these places.

Merging With Highway Traffic - Like crossing traffic, merging with traffic demands wise driver judgment. You merge when you change lanes on a multi-lane highway and when you enter a highway from a ramp. In either case, you need enough space to move safely into the traffic stream.

Entrance ramps for highways often have acceleration lanes. These lanes run beside main traffic lanes and should be long enough to let you reach highway speed before you enter the highway itself. These

lanes also allow drivers on the highway to see you before you enter the road. You must come to a complete stop when it is not possible to merge into traffic. **Remember, it is illegal to pass a vehicle ahead of you on an acceleration lane.** You may pass a slower vehicle only after you have merged safely into traffic, and can safely and properly enter the left lane(s).

To use an acceleration lane, follow these steps:

1. Look for an opening in traffic;
2. Accelerate to the speed of traffic; and
3. Merge safely into the opening in traffic. Do not try to squeeze into an opening that is too small.

Leaving Highway Traffic - When leaving a highway, plan ahead of time what exit you will use, and get into the proper lane in plenty of time. To exit, signal first, then move into the appropriate lane. When you reach the exit lane, slow down to the advised speed posted on the exit lane.

If you miss your exit, do not stop or back up. Go to the next exit, turn around and come back to the exit you missed.

Passing

Passing is a very important portion of driving. If not done properly, passing can be a very dangerous or fatal maneuver. To accomplish passing safely, there are some guidelines you should follow which vary according to the situation.

Safe Passing Procedures - When you decide there is enough clear road to allow safe passing, you should do the following:

1. Look for signs and pavement markings. Many roads have signs and lane markings that tell you when you can or cannot pass safely under normal driving conditions. Examples of these can be found in Chapter II.
2. Look ahead carefully before you start to pass and check for any dangers in the passing area.
3. Look in your side and rearview mirrors and quickly check your blind spots. Make sure there are no vehicles about to pass you when you start to pass.
4. Before passing, give the proper turn signal to show you are going to move into another lane. Signal early enough so that others will know your plans ahead of time.
5. After passing, signal that you plan to return to your lane.
6. Before you move back into the lane, make sure you can see the front of the vehicle you passed in your rearview mirror.

When passing, be extra careful in areas where vehicles or pedestrians might enter or cross the road. These places include crossroads, railroad crossings, and shopping center entrances and exits. When you are passing, your view of people, vehicles, or trains may be blocked by the vehicle you are passing. Also, a driver turning onto the roadway and into the left lane will not expect to find you in that lane and may not even look your way.

Passing on a Two-Lane Road - To pass another vehicle on a two-lane road, you must enter a lane that belongs to oncoming vehicles. This calls for good judgment. To be sure that you will have enough time to reenter the proper lane safely after passing, think about the following factors:

- The speed of the vehicle you are about to pass compared to your vehicle's speed.
- Your vehicle's ability to accelerate. Quick acceleration may be necessary to avoid surprise problems when you are passing.

- The speed and distance of any oncoming vehicle.
- How far both vehicles will travel before you can pull back into line.
- The clear distance ahead of you.
- The space you will have to move back into line ahead of the passed vehicle.
- Any other possible hazards, such as weather conditions, night driving vision limitations, and other risk factors.

Passing on the Right - You may pass another vehicle on the right side under certain conditions, but pass only if you can do so safely. Here are the conditions which allow you to pass on the right:

1. When the driver you are passing is making or signaling a left turn.
2. When driving on a roadway with two or more marked traffic lanes in each direction.

Passing on Multi-Lane Highways - To pass on a multi-lane highway, you will not have to worry about vehicles approaching from the opposite direction, but you must signal and check that the lane you are about to move into is clear of traffic. Always make sure you signal your plans both before passing and before returning to your original lane.

You May Not Pass in the Following Conditions:

- When you are within 100 feet of or are crossing any intersection or railroad grade crossing, unless an official traffic control device says you may.
- When you are within 100 feet of any bridge, elevated structure or tunnel because these may block your view.
- When you are approaching or are on a curve or a crest (top) of a hill on a two-lane road if your view of oncoming vehicles is blocked.
- When you are on a shoulder of a multi-lane highway.

Parking

If the street you are on has a curb, park as close to it as you can but no more than 12 inches away. If it has no curb, pull as far off the roadway as possible.

When you must park on the roadway, activate your four-way flashers and give enough room to passing vehicles. Make sure your vehicle can be seen at least 500 feet in both directions.

Always park in the direction that traffic moves. Make sure your vehicle cannot move. Set your parking brake and shift to "Park" if your vehicle has an automatic shift, or to "Reverse" or "First" if your vehicle has a manual shift. If you are parked on a hill, turn your wheels as follows:

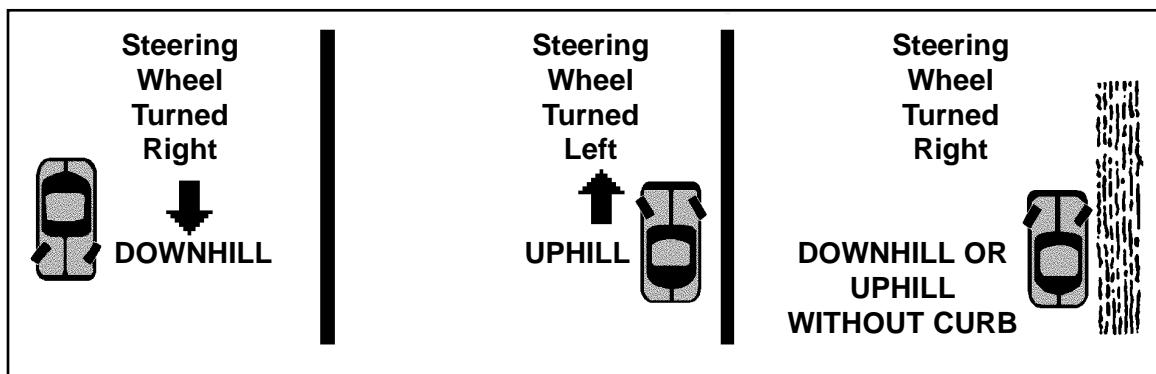

Before leaving your vehicle, turn off the engine, remove the key and lock all doors. Check for traffic behind you before you get out.

Except in emergencies or unless a police officer tells you to do so, never stop, stand or park your vehicle at the following places:

- On the roadway side of a vehicle already stopped or parked along the edge or curb of the street (“double parking”)
- On the sidewalk
- Within an intersection
- On a crosswalk
- Along or opposite any street digging or work area
- On any bridge or other elevated structure or in a highway tunnel
- On any railroad tracks
- Between roadways of a divided highway, including crossovers
- Within 50 feet of the nearest rail of a railroad crossing
- At any place where official signs prohibit parking
- At any place where official signs prohibit stopping
- In front of a public or private driveway
- Within 15 feet of a fire hydrant
- Within 20 feet of a crosswalk at an intersection
- Within 30 feet of any flashing signal, stop sign, yield sign, or traffic control device located at the side of a roadway
- Within 20 feet of a driveway entrance to a fire station
- Where your vehicle would prevent a streetcar from moving freely
- On a limited access highway, unless official traffic control devices indicate that you may

ADJUSTING SPEED

What is a safe speed? How fast is too fast? There are no simple answers to these questions because there is not a single speed that is safe at all times. The speed you can safely drive depends upon:

- Conditions of the road
- Condition of tires and brakes
- Traffic flow
- Reactions to slow-moving traffic
- Posted speed limits

Conditions of the Road

Slippery Roads

Tires lose some of their grip on slippery roads. For this reason, you must drive more slowly on wet roads than you would on dry ones. Be extra careful on roads posted with warning signs.

Here are some tips to help you drive safely when roads get slick:

- On cold, wet days, shade from trees or buildings hides spots of ice. These areas freeze first and dry last.
- Bridges and overpasses tend to freeze before roads do.
- Pavements can become very slippery for the first few minutes of a rain storm. The rain causes oil in the asphalt to come to the surface. This oil makes a road slippery until the oils wash off in heavy rain. This problem becomes even worse during hot weather when the heat combined with the water causes even more oil to rise to the road surface.
- An ice-covered road with a thin layer of water is more slippery than ice alone. Use extra care when temperatures get near the melting point.
- Wet leaves can cause slippery conditions.
- It takes longer to stop your vehicle on slippery roads. Increase the space cushion between you and other vehicles.

Do not slam your brakes on slippery roads. Hard braking can lock your wheels and cause loss of steering. Apply brakes gently, ease off if you start to skid and reapply when you regain control. If your vehicle is equipped with an antilock braking system (ABS), refer to your owner's manual for the proper braking procedure to use.

Water on the Roadway

Most tires will wipe water from the road surface when they are driven at speeds up to 35 miles per hour. They work like a windshield wiper cleaning water off a windshield. But as you drive faster, your tires cannot wipe the road as well.

The tires start to ride like water skis on a film of water. This is called "hydroplaning." It is usually caused by excessive speed, but it can even happen at speeds of 35 miles per hour.

Because of this, in a heavy rain your tires can lose all contact with the road at higher speeds. Worn tires lose contact faster. A small change in direction or a gust of wind could throw your vehicle into a skid. The best way to prevent hydroplaning is to keep your speed down and have good tire tread.

Flooded Roadways

Flooded roadways are extremely dangerous to both drivers and passengers. **NEVER ATTEMPT TO DRIVE ACROSS A FLOODED ROAD.** As little as six inches of water can float some small cars. Two feet of water will carry away most vehicles. Once a vehicle floats off the roadway into deeper water, it may roll uncontrollably while filling with water, trapping the driver and all passengers in the vehicle.

In the United States, nearly half of all flash flood fatalities are people who were trapped in vehicles. In many cases, victims drive right off the edge of an eroded roadway without knowing the road is no longer there.

Flooded roadways are especially dangerous at night when it is more difficult to recognize the flood dangers. If your vehicle stalls in a flooded roadway, leave it immediately and seek higher ground.

Slick Winter Roads

To make your vehicle safer in winter conditions, it should be equipped with all-season radial tires, snow tires or chains. When driving on snow or ice, accelerate slowly and try not to spin the wheels. Adjust your driving to compensate for lost traction and reduced braking ability. When driving on slick roads:

- Reduce your speed and increase the space between you and other vehicles.
- Avoid making any sudden moves—no fast turns, no quick accelerations, no hard braking.
- Watch for ice patches, wet leaves and bridges, which freeze before road surfaces.

Curves

To keep your vehicle on the road, slow down before you enter a curve. Take turns and curves slower than you would under normal conditions. If you are going too fast, your tires may skid. Increase your speed only after you have the feel of the curve.

Different types of signs exist to warn you of approaching curves or turns, but you will not find a sign for every curve or turn. Sharp curves or turns are usually posted. (Examples of these signs can be found in Chapter II.)

Condition of Tires and Brakes

Tires are the only contact your vehicle has with the road. At any time your tires have only one square foot of rubber on the surface of the road. How well one square foot of rubber grips the road depends on the condition of your tires and of the road itself.

Drivers often do not react correctly to road conditions. When drivers do not react in the right way, they may lose control of their vehicle and cause a crash.

When deciding what speed is safe, you should always consider the condition of your tires and your brakes. If your tires are in good condition but your brakes are worn, you may still be unable to stop safely. Worn or bald tires increase your stopping distance.

Traffic Flow

Crashes often happen when drivers change direction or when some drivers go faster or slower than other vehicles on the road.

Since traffic movement is often confusing, you must stay alert and make many decisions in a short amount of time. Try to drive with the flow of traffic within the posted speed limit. Each time you pass another vehicle, you increase your chance for error. Keep in mind that going slower than other vehicles can also be dangerous.

Reactions to Slow-Moving Traffic

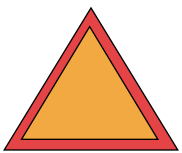

Some vehicles have trouble keeping up with the speed of traffic. Watch out for these vehicles and slow down early if you see one. Large trucks and under-powered vehicles often lose speed on long or steep hills and may use their flashers to alert motorists. When entering traffic, these vehicles take longer to pick up speed. Look out for farm tractors and animal-drawn vehicles, which display an orange triangle on the back and are designed to operate at 25 miles per hour or less. Bicycles are also usually slower and may be more difficult to see.

Posted Speed Limits

On interstate highways and other freeways, the maximum speed limit is 65 miles per hour where posted. The maximum speed limit on other highways is 55 miles per hour unless signs are posted with a lower speed limit. In school zones, the speed limit is 15 miles per hour when the lights on the school zone sign are flashing or during the time period indicated on signs.

Posted speed limits indicate what the maximum safe driving speed is in order to drive under the best conditions. When the road is wet or slippery, when you cannot see well or when anything else makes conditions less than perfect, you should drive below the posted speed limit. When you are deciding how far below the posted speed limit to drive, you must consider both road and weather conditions.

SPECIAL CIRCUMSTANCES

Pay close attention to your driving and be extra careful when you see:

- School buses
- Emergency vehicles/situations
- Funeral processions
- Motorcycles and mopeds
- Bicyclists
- Horseback riders and horse-drawn vehicles
- Trucks and buses
- Pedestrians
- Railroad crossings

School Buses

Where you see school buses, you may see children walking to and from the bus. Sometimes children may run out of buses and across busy streets. Pennsylvania has special rules that you must follow when you drive near a school bus. These rules protect both children and drivers.

When a school bus is preparing to stop, its amber (yellow) lights will begin flashing. You **MUST** prepare to stop.

When a school bus stops and its red lights are flashing and its stop arm is extended, you must stop at least 10 feet away from the bus, whether you are behind the bus, coming toward it on the same roadway or approaching an intersection at which the school bus is stopped. Remain stopped until the red lights stop flashing, the stop arm has been withdrawn and the children have reached a safe place.

ALL VEHICLES MUST STOP!

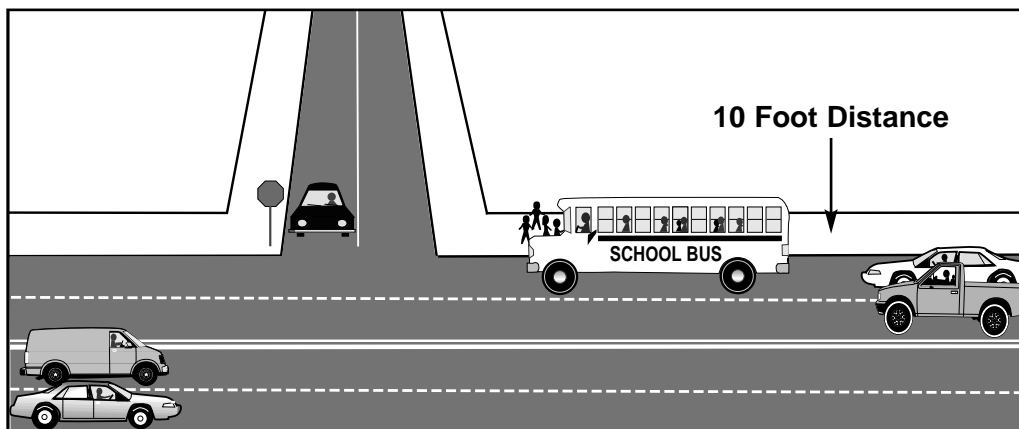

There is only **ONE** exception to the school bus stopping requirement. If you are approaching a school bus that is stopped with its red lights flashing and stop arm extended and you are driving on a separate roadway or the opposite side of a divided highway, you do not have to stop. Reduce your speed and continue driving with caution.

Separate or divided roadways are roads that are divided by physical barriers such as metal median barriers (guiderails), concrete median barriers, and non-mountable curbs.

Other examples of divided highways include separate roadways that have clearly indicated dividing sections such as strips of grass, a stream, trees and shrubs, rocks and boulders, or concrete mountable curbs.

Emergency Vehicles/Situations

Certain vehicles have sirens and flashing red lights or a combination of flashing red and blue lights. The lights assist emergency vehicles to move quickly through traffic and to answer emergency calls. Emergency vehicles include fire department equipment, police cars, ambulances, blood delivery vehicles and specially equipped vehicles from river rescue organizations, but other types do exist. Watch out for them.

When you hear a siren or see a vehicle approaching with flashing red (or a combination of red and blue) lights, pull over to the curb or edge of the road and stop. Drive parallel and as near to the curb as possible. On one-way streets, drive toward the road edge nearest you. Always stay clear of intersections.

After the emergency vehicle passes, you may start driving again. You must stay at least 500 feet away from the emergency vehicle.

If an emergency vehicle is leaving or returning to its garage and the emergency lights are still flashing, you must stop until the emergency vehicle is safely out of your path.

During an emergency situation, all drivers must obey the direction of any uniformed police officer, sheriff, constable or any properly attired person, including fire police.

Funeral Procession

If you see a funeral procession on the road, yield to vehicles in the procession. Once the lead vehicle has cleared an intersection, the rest of the procession has the right-of-way. Allow the procession to pass and do not cut in and out of the procession, unless you are directed otherwise by a police officer or an agent or employee of the funeral director during a funeral.

All vehicles in a funeral procession must have their headlights and emergency flashers turned on and bear a flag or other insignia designating them as part of the procession.

Drivers in funeral processions may proceed through a red light or stop sign **IF** the lead vehicle starts through the intersection while the light was green or, in the case of a stop sign, the lead vehicle first came to a complete stop before proceeding through the intersection.

Motorcycles and Mopeds

When you see a motorcycle approaching, make sure you give it enough space. When you pass a motorcycle, do not try to squeeze past it in the same lane. According to the law, you must allow the motorcyclist to use one complete lane.

Remember these tips when you share the road with motorcyclists:

- Most motorcycle/automobile crashes occur because the automobile driver fails to see the motorcycle. Motorcycles are small and, therefore, more difficult to see. Their size also allows them to easily duck into your blind spot. Be alert for motorcyclists. Expect motorcycles to be part of the traffic flow.
- Do not assume a motorcycle is turning when you see its turn signal flashing. Motorcycle turn signals may not turn off automatically, and the rider may have forgotten to turn them off. Do not pull out in front of a motorcycle until you see that it is actually beginning to turn.
- Obstacles that may prove minor to a motorist can be deadly to a motorcyclist. Be prepared for a motorcyclist's sudden change in lanes or speed as they attempt to avoid a hazard on the road. Allow room for the motorcyclists to maneuver.
- Allow the same four-second following distance or more that you would allow for other vehicles. If you follow too closely, you may distract the rider. If the rider makes a mistake, you will not have enough time or space to avoid a crash.

- Allow an even longer following distance when road or weather conditions are bad.
- Motorcycles and other vehicles can share the road safely. We simply need to understand each other's traffic needs.

Bicyclists

Bicyclists are vehicle operators, and they are expected to obey all traffic laws and regulations. As a motorist, you should know that a bicyclist has the same rights, privileges and responsibilities as you. Respect for each other will aid in the smooth flow of traffic.

Like motorcycles, bicycles may not be easily seen in traffic. You have to be alert for bicycle riders and take extra care when you approach them. Remember these points as you share the road with bicyclists:

- Do not sound your horn close to bicyclists. It may startle them and cause them to steer into your path. If you feel that you must use your horn, tap it quickly and lightly.
- When approaching or passing a bicycle, slow down and allow as much clearance as possible.
- When making turns, watch carefully for bicyclists entering your lane. Be especially alert if you see children riding bikes on the sidewalk. They may come onto the road.
- Never turn sharply in front of a bicycle. It is illegal to force a bicyclist off the road and you may face criminal charges.
- Bicyclists may be hard to see against a background of parked cars or pedestrians.
- Cooperate with bicyclists. They are required to use hand signals, as follows, when turning and stopping and will frequently help you to pass safely by signaling that it is clear to pass or that oncoming traffic will not permit you to pass safely. However, keep in mind that a bicyclist may be unable to signal if road or traffic conditions require them to keep both hands on the handlebars.

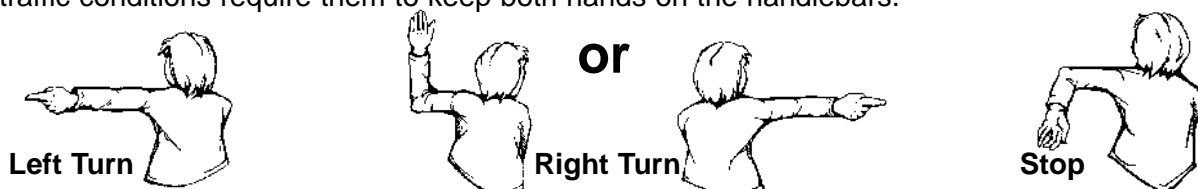

- Be particularly careful when the roadway is wet or covered with sand or gravel. Like motor vehicles, bicycles cannot brake as quickly or turn as sharply under these conditions.
- After you have passed a bicyclist, do not slow down or stop quickly. Motor vehicle brakes are more powerful than a bicycle's and you could cause a crash.
- Consider a bicyclist's speed when you pass. For example, if you are about to make a right turn, do not pass a bicyclist immediately before the turn. You will have to slow down so quickly that the bicyclist may collide with you. When your vehicle is following a bicyclist, slow down and make your turn after the bicyclist has cleared the intersection.
- Never ride your bicycle under the influence of alcohol or a controlled substance. If found guilty of riding under these conditions, you can lose your driving privilege.

Horseback Riders and Horse-Drawn Vehicles

When meeting or passing a horseback rider or a horse-drawn vehicle, you should do so with caution and be prepared to stop. Frightened horses can dart into the path of your vehicle without warning. When approaching a horseback rider or horse-drawn vehicle, follow the same points listed for bicyclists.

Trucks & Buses

Trucks

Whether you are sharing the road with a car, truck, bus or other large vehicle, it is important for safety's sake to obey traffic laws, abide by the rules of the road and drive defensively.

There are special rules for sharing the road with trucks, and the following are some suggestions you can use to make your trip safer: The key to safer highways is to know the truck's blind spot (**No-Zone**). The No-Zone represents danger areas around trucks and buses where crashes are more likely to occur.

Passing a Truck

On a level highway, it takes only three to five seconds longer to pass a truck than a car. On an upgrade, a truck often loses speed, so it is easier to pass than a car. On a downgrade, the trucks momentum will cause it to go faster, so you may need to increase your speed.

When cars cut in too soon after passing and then abruptly slow down, truck drivers are forced to compensate with little time or room to spare.

Complete your pass as quickly as possible and do not stay along side the other vehicle. Be sure to move back only when you see the front of the truck in your rearview mirror. After you pass a truck, maintain your speed.

Truck Passing

When a truck passes you, you can help the truck driver by keeping to the far side of your lane. You will make it easier for the truck driver if you reduce your speed slightly. In any event, do not increase your speed while the truck is passing you. Trucks have much larger No-Zones on both sides of their vehicle than passenger vehicles (cars). When you drive in these No-Zones, you can't be seen by truck drivers.

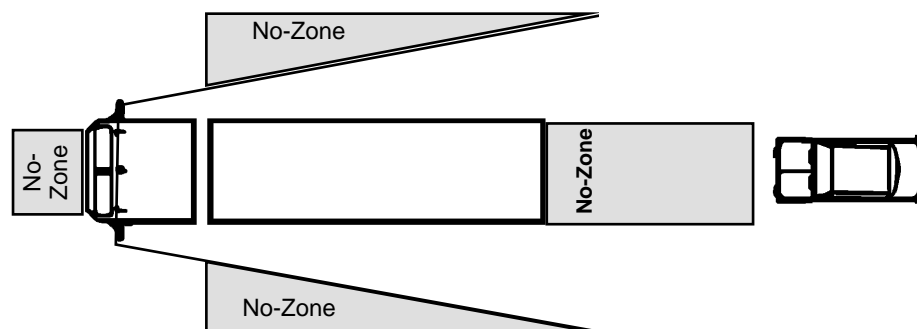

An example of a truck's blind spots (No-Zones).

When you meet a truck coming from the opposite direction, keep as far as possible to the side to avoid a sideswipe crash and to reduce the wind turbulence between your vehicle and the truck. Remember that the wind turbulence pushes vehicles apart. It does not pull them together.

Following a Truck

Because of their size, trucks need longer distances to stop. However, a car following too closely still may not be able to stop quickly enough to avoid rear-ending the truck. If you are following a truck, stay out of its No-Zone. Avoid following too closely and position your vehicle so the truck driver can see it in his side mirrors. You will then have a good view of the road ahead and the truck driver can give you plenty of warning for a stop or a turn. You will have more time to react and make a safe stop. When

following a truck or bus, if you cannot see the side mirrors of the vehicle in front of you, the driver of the large vehicle cannot see you.

When you follow a truck or any vehicle at night, always dim your headlights. Bright lights from a vehicle behind will blind the truck driver when they reflect off the truck's large side mirrors.

Turns

Pay close attention to truck turn signals. Truck drivers must make wide turns so that the rear of the truck or the rear of a tractor trailer can clear the corner or any other standing obstructions. Sometimes space from other lanes is used to clear corners. To avoid a crash, do not pass until the turning action is complete. Again, pay close attention to turn signals. (See example below.)

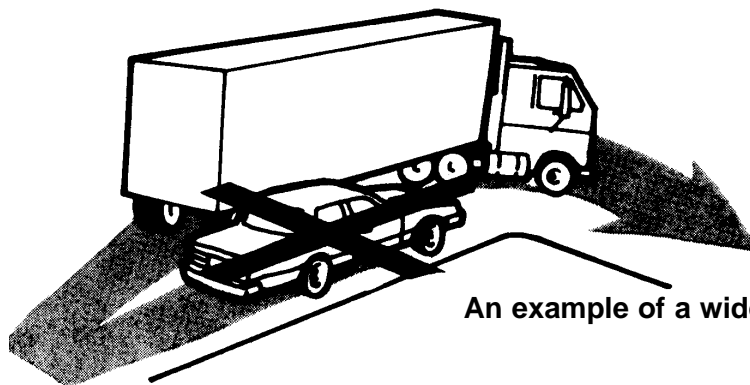

An example of a wide right turn.

Backing Crashes

Never try to cross behind a truck that is preparing to back up. Often when a truck driver is preparing to back the truck from a roadway into a loading area, there is no choice but to temporarily block the roadway. It is here that some drivers and pedestrians attempt to pass behind the truck rather than wait the few seconds for the truck to complete its maneuver. In passing close behind the truck, the driver or pedestrian enters the truck's No-Zone and a crash may occur.

Braking

Unlike the hydraulic brakes on automobiles, trucks and buses may have air brakes. A loaded truck with good tires and properly adjusted brakes, traveling at 65 mph on a clear, dry roadway, requires a minimum of 600 feet to come to a complete stop (compared to the stopping distance of 400 feet for a passenger vehicle). It is essential to refrain from entering a roadway and, if you are turning off the roadway, to avoid changing lanes in front of a large vehicle.

Escape Ramps

On long downgrades there may be special "escape" or "runaway" ramps for trucks. These ramps are to be used only by large vehicles that are out of control or cannot stop because of brake failure. Never stop or park in the vicinity of these ramps.

Buses

Buses are vehicles that also take up more room on a road than an ordinary vehicle. The same procedures should be followed when sharing the road with a bus or truck.

Pedestrians

- Yield to pedestrians crossing at intersections or in crosswalks.
- When approaching a stopped car from behind, slow down and do not pass until you are sure that there are no pedestrians crossing in front of it.
- Right turn on red means STOP, LOOK in all directions, and then turn when it is safe. Look for pedestrians and allow ample time for them to clear the crosswalk.
- Be extra attentive when driving at night or during other periods of reduced visibility. Keep your windows fog and frost free. Even with good visibility, pedestrians are less conspicuous than vehicles.
- Always reduce speed when passing children. You must observe school zone speed limits and stop for school buses when red signals are flashing.
- Be patient with elderly pedestrians. Usually they need extra time to cross a street.
- Before backing, always check for pedestrians in your path.
- Be especially considerate to pedestrians with disabilities.
- Yield the right-of-way (stop if necessary) to blind pedestrians, whether they have a white cane or a guide dog or are led by others.

Railroad Crossings

Most railroad crossings are protected only by an advanced warning sign and a crossbuck. Most crossings do not have gates to stop traffic. You must be especially alert when approaching all railroad crossings.

Familiar crossings without much train traffic can be the most dangerous. If you often use such a crossing and do not usually see a train, you may start to believe that trains never go by. Believing this can be dangerous.

Crossings with complicated or confusing traffic patterns nearby are also dangerous. They cause drivers to pay more attention to traffic on the road than to an approaching train.

Always look left, right and then left again as you approach a railroad crossing. Look, even if the warning sign is not flashing. It may not be working. The following points are also good to remember:

- If you are stopped at a railroad crossing with more than one track, do not start as soon as the train passes. Wait until you have a clear view down both tracks; look left, right and then left again before you start across. Another train could be coming from the other direction.
- Never drive onto a railroad track until you are sure you can drive all the way across. Make sure the traffic ahead of you will not stop and keep you from crossing. Wait for the traffic to clear before you cross.
- If you make the mistake of getting trapped on a railroad crossing and a train is approaching, quickly leave the car and move as far away from the track as you can.

EMERGENCY DRIVING SKILLS

Even if you obey all traffic laws and drive safely, things may happen that you do not expect.

If you are like most drivers, you will not have the chance to practice how you would act in an emergency before it happens. Knowing how to handle driving emergencies may help you avoid a crash.

When you come across an emergency, you may have to do any or all of the following to handle it:

- Steering
- Accelerating
- Braking

Steering

You must have good steering skills to keep control of your vehicle. In an emergency, you must react quickly and correctly to avoid a crash. It is better to swerve right instead of toward oncoming traffic to prevent a crash.

For normal, straight-line driving, your hands must be in a balanced position on the steering wheel. You should become familiar with holding the steering wheel this way all the time. When turning, you should use the hand-over-hand or the “push-pull” steering method. These methods allow you to turn the wheel quickly and smoothly and still remain in control of your vehicle.

The method of steering called “push-pull” is generally recommended over the “hand-over-hand” method because it requires less strength and avoids crossing of the arms, which can cause injury in a crash where the air bag deploys. It begins with the hands in the 8- and 4-o'clock positions. When making a left turn, grip the wheel with the right hand and push up while the left hand slides up to 12 o'clock. The right hand stops pushing at the 1 o'clock position and the left hand grips at 12 o'clock and pulls down. Continue to push and pull as needed. For right-hand turns, reverse the procedure.

Accelerating

Sometimes you must increase your speed to avoid a crash (e.g., if another vehicle is about to hit you from the side or from behind).

Braking

Even though you must sometimes brake to avoid a crash, braking the wrong way can cause a crash.

In emergencies many drivers slam on their brakes. If your vehicle is equipped with a conventional braking system, this locks the brakes, makes the vehicle skid and makes steering impossible. Pressing and releasing the brakes repeatedly is usually the best way to stop. The vehicle stops faster and you keep your vehicle under control. This technique helps you avoid crashes.

If your vehicle is equipped with an antilock brake system (ABS), you must maintain firm and continuous pressure on the brake while steering—your car will not skid. Don't be alarmed by mechanical noises and/or slight pulsations. For additional information, check your owner's manual for braking instructions.

HANDLING DANGEROUS DRIVING CONDITIONS AND VEHICLE EMERGENCIES

Sometimes you will have to face dangerous driving conditions and vehicle emergencies. No matter how well you take care of your vehicle, it may still break down. Here are some tips for handling these types of situations:

Skidding

Skidding often results from driving on icy or wet roads or from high speeds. If your vehicle starts to skid, **Turn the steering wheel in the direction you want your vehicle to go.** If the rear of your vehicle is skidding to the left, turn the wheel to the left. If the rear of your vehicle is skidding to the right, turn the wheel to the right. When you steer to correct a skid, another skid may result in the opposite direction, but the second skid will not be as bad as the first. Be ready to stop the second skid by steering in the direction of the skid again. It may take a few steering movements to regain control of your vehicle.

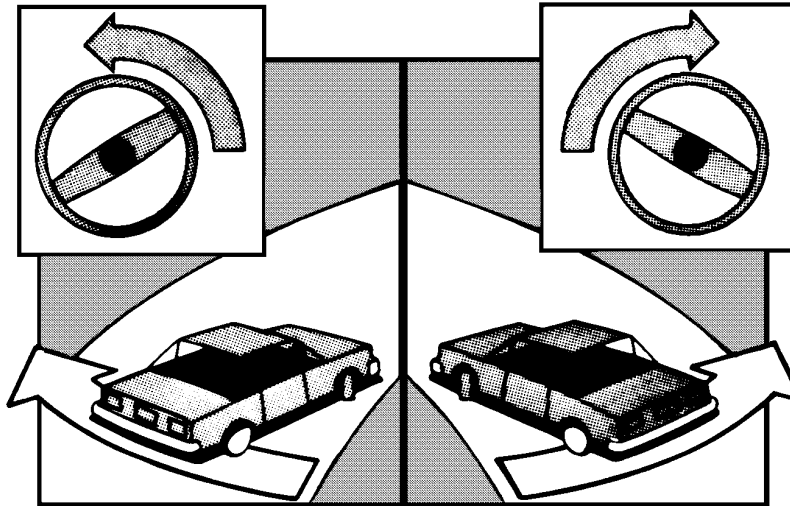

Another way of saying “**turn in the direction your vehicle is skidding,**” is to say “**turn the wheel toward the center of your lane of travel.**” Both techniques solve the skid problem in the same way. So, use whichever one is easiest for you to understand and remember.

When skidding, do not use your brakes. If you hit the brakes, the skid will be worse. By braking you also risk locking your wheels and losing all control of steering.

Handling Slippery Surfaces—Road Conditions

Skids happen most often on slippery surfaces. Be aware that as the temperature rises to the point where ice begins to melt, the road becomes even more slippery. Even a road that is usually safe can be dangerous when slippery. Ice and packed snow can cause your vehicle to skid, especially when you are driving at high speeds or going downhill. “Hydroplaning” also causes skids. Hydroplaning happens when your tires begin to ride on a film of water and do not grip the road. Worn tires and excessive speed increase the chances of hydroplaning.

If you are about to drive over a slippery surface or if your vehicle is hydroplaning, these tips may help you avoid a skid:

1. Slowly take your foot off the gas pedal.
2. Turn slowly and only as much as necessary to keep your vehicle on the road.
3. If you have to use your brakes, press gently and release them repeatedly unless your vehicle is equipped with an antilock brake system (ABS), in which case refer to your vehicle owner's manual.
4. Do not try to stop or turn quickly.

Brake Failure

If your brakes suddenly fail:

1. Shift to low gear and look for a place to slow to a stop.
2. Pump the brake pedal quickly several times. This will often build up enough brake pressure to stop the vehicle. If that does not work, use the parking (emergency) brake and hold the brake release so you can let off the brake if the rear wheels lock and you begin to skid.
3. Make sure that the vehicle is off the roadway.
4. After the vehicle has stopped, call for help. Do not try to drive the vehicle to a garage.

Blowout

Sometimes thumping noises start before a tire blows out, but you usually will not know ahead of time when a tire will blow. You should protect against blowouts by keeping your tires in good condition and properly inflated.

If one of your vehicle's tires blow out:

1. Hold the steering wheel tightly.
2. Slowly take your foot off the gas pedal.
3. If you have to use your brakes, press them gently.
4. Let the vehicle slow to a stop. Make sure it is off the road before you change the tire.

Stalled Engine

If the engine stalls:

1. Hold the steering wheel tightly. You will have trouble steering if your vehicle is equipped with power steering.
2. Shift to neutral.
3. Try to restart the engine. If that does not work, brake gently to stop the vehicle. If you have power brakes on your vehicle, they will lose their power if the engine stalls, and you will have to press them hard. Try to pull off the road and turn on emergency flashers.

Headlight Failure

If your headlights suddenly go out:

1. Slow down.
2. Try pressing or pulling on the high-beam switch a few times. It may turn the headlights on again.
3. If this step does not work, try turning on the parking lights, emergency flashers, or turn signals.
4. Pull off the road and leave the emergency flashers on, if they work.

Accelerator Sticks

If the accelerator (gas pedal) sticks, the vehicle will often keep going faster and faster. In this case:

1. Keep your eyes on the road.
2. Shift to neutral immediately and use the brakes.
3. Concentrate on steering.
4. Push hard and release the accelerator pedal with your foot.
5. Pull off the road when you have slowed down to a safe speed.
6. Stop, turn off the engine and turn on your emergency flashers.

NOTE: If vehicle is equipped with power steering and power braking and you turn off the ignition, you will lose power but will have more difficulty with steering and braking.

Drifting Off the Pavement

If your wheels drift onto the road shoulder, SLOW DOWN GRADUALLY until you can safely pull back onto the road. If the shoulder lies below the edge of the road, avoid rubbing your tires against the pavement edge.

KEEPING IN SHAPE FOR DRIVING

Driving is one of the most complex things you do. It takes years of practice to develop the skills and judgment for good driving.

If anything happens to lessen your driving ability, your performance will be impaired. You will risk your life and the lives of others. Your driving ability is affected by lack of sleep/alertness, anger, consumption of alcohol and/or illegal drugs, the side effects of medication, poor vision/hearing, and poor health.

Alertness

Driving requires constant awareness of everything around you such as speed, signs, and road conditions. If you find your concentration waning or drifting or you are getting tired, stop driving, at least for a little while. A short rest can make a difference in your ability to handle the road.

When using a cellular phone it is recommended for safety purposes that you pull to the side of the road to make or receive any calls.

Anger and Aggression

Anger and aggression hinder good judgment. Angry drivers do unsafe things. **NEVER** take your anger out on someone else on the road. **NEVER** take it personally when someone cuts you off or pulls out in front of you and **NEVER** get into a confrontation with another motorist. If something does happen, **DO NOT RETALIATE**. If necessary, contact the police from the nearest telephone.

When you are angry, try to relax and put yourself back in control.

Vision

You need good vision for driving. Most driving skills depend upon the driver's sight. Good eyesight means:

- Seeing clearly. If you cannot see clearly, you cannot judge distances or spot trouble.
- Good side vision. You need to see "out of the corners of your eyes," so you can spot cars on either side of you while your eyes are looking ahead.
- Judging distances. You can see clearly and still be unable to judge distances. Good distance judgment is important.
- Good night vision. Many people who can see clearly in the daylight have trouble seeing at night. Some cannot see clearly in dim light. Others may have trouble with the glare of headlights.
- Have your eyes checked every one or two years. You may not notice if your side vision or distance judgement deteriorates unless your eyes are examined regularly.

Hearing

Hearing is more important to drivers than many people realize. Your hearing can warn you of danger. Sometimes you can hear a car that you cannot see in your blind spots. Hearing problems, like bad eyesight, can start so slowly that you do not notice them. Drivers who are deaf or have hearing problems can adjust. They learn to rely more on their vision. Regular hearing checks will help to detect any changes in hearing or hearing loss. Some drivers who have a hearing impairment may be restricted to the operation of a vehicle equipped with outside mirrors.

Health

Health problems, such as bad colds or infections, can affect your driving. Even little problems like a stiff neck, cough or a sore leg can limit your driving ability.

The following health problems can be especially dangerous:

- **Seizure disorders (like epilepsy and others)** - Seizure disorders are dangerous only when they are not under medical control. In Pennsylvania, you must be seizure-free for six months before you will be allowed to drive. Your physician must complete a medical report stating this and send it to PennDOT.
- **Diabetes** - Individuals taking insulin should not drive when there is any danger of an insulin reaction. This danger could result from taking the wrong amount of insulin. It is important to check your blood sugar before driving and periodically while driving on long trips. A person with diabetes should always have some form of sugar available in the car in case low blood sugar should occur. It is suggested that individuals newly diagnosed as having diabetes have a friend or relative drive for them when their doctor is checking and adjusting the insulin dosage. Also, people with diabetes should regularly have their eyes checked since night blindness and other vision changes may occur.
- **Heart Condition** - People with heart disease, high blood pressure or circulation problems should know the dangers of these conditions and how they can limit one's driving ability. These problems may cause blackouts, fainting spells or heart attacks.

TRIP PLANNING

An important but often forgotten part of driving is trip planning. Whether you are traveling several hundred miles or just to an unfamiliar part of your own town, you need a basic idea of how to get where you want to go. Good trip planning can help cut down your need to slow down, stop quickly or make sudden turns. Trips will be safer and more enjoyable, too.

If you are going on a trip, you should do the following:

1. Get enough rest before you start. Get a normal night's sleep.
2. Leave early enough for your destination to allow for traffic congestion or road construction.
3. Do not take any drugs that can make you drowsy, even the night before you start.
4. Do not drive non-stop for long periods of time. Driving without stopping to rest every two hours can be very dangerous. Set a limit of 300 to 400 miles a day. Stop and rest every 100 miles or every two hours. Limit yourself to 8 to 10 hours of driving a day.

The basic tool for planning a trip is a road or street map. These maps are usually easy to get. Most maps show recreational areas and other interesting places, as well as roads and towns. Some maps even include blowups of city areas on the back.

To use a map when you plan a trip, follow these steps:

- Find the map's legend. Pay close attention to the symbols, the map scale and all other information on the map.
- Find your starting and finishing point. Decide what routes you will use to travel between them. Note the route numbers, street names and direction you will travel on each route. Pay close attention to places where you must change routes. These are important decision points.
- Get to know the area around each decision point. Town names are often marked on guide signs. By knowing the towns around a decision point, you can travel through these decision points more easily.
- Finally, if you are planning to use a limited access highway (such as a freeway, turnpike or expressway), use the map to find the interchange nearest your destination. Remember the exit just before your exit so you will be ready to turn off. Sometimes roads that seem to cross expressways on maps do not intersect the freeway or expressway but instead cross over or under it. Most maps show interchanges with either squares or circles.

DRIVING RECORD INFORMATION

This chapter will provide the information you need to know about your driving record. PennDOT maintains a driving record for every licensed driver in Pennsylvania. The Bureau of Driver Licensing receives reports on various offenses and convictions from the police and courts. A history of such reports is kept by the Bureau on every driver. If you would like a copy of your driving record, you should obtain an Application to Request Driver Information (Form DL-503).

PENNSYLVANIA'S POINT SYSTEM

The purpose of the point system is to help to improve driving habits and to ensure safe driving. Points are added to a driving record when a driver is found guilty of certain driving violations. PennDOT begins to take corrective action when a driving record reaches 6 or more points.

When a driving record reaches 6 or more points for the first time, the driver will receive a written notice to take a written special point examination. When the driving record is reduced below 6 points and reaches 6 or more points for a second time, the driver will have to attend a departmental hearing. Further accumulations of 6 or more points will result in additional departmental hearings and sanctions to your driving privilege.

In addition to these requirements, the driving privilege of a person under the age of 18 will be suspended if that person accumulates six (6) or more points or is convicted of driving 26 miles per hour or more over the posted speed limit. The first suspension will be for a period of 90 days. Any additional occurrences will result in a suspension of 120 days.

The following indicates the violations and the number of points given:

Section No. of Vehicle Code	Description	No. of Points
1512	Violation of restriction on driver's license; wearing glasses, etc	2
1571	Violation concerning license	3
3102	Failure to obey policeman or authorized person	2
3112(a)(3)(i)or(ii)	Failure to stop for a red light	3
3114(a)(1)	Failure to stop for a flashing red light	3
3302	Failure to yield half of roadway to oncoming vehicle	3
3303	Improper passing, overtaking vehicle on left	3
3304	Improper passing on the right	3
3305	Improper passing on the left, clear distance ahead	3
3306(a)(1)	Improper passing on a hill	4
3306(a)(2)	Improper passing at a railroad crossing or intersection	3
3306(a)(3)	Improper passing at a bridge or tunnel	3
3307	Improper passing in a no-passing zone	3
3310	Following too closely	3
3321	Failure to yield to driver on the right at intersection	3
3322	Failure to yield to oncoming driver when making left turn	3
3323(b)	Failure to stop at stop sign	3
3323(c)	Failure to yield at yield sign	3
3324	Failure to yield when entering or crossing roadway between intersections	3
3332	Improper turning around-illegal U-turns	3
3341(a)	Failure to obey signal indicating approach of train	2
3341(b)	Failure to comply with crossing gate or barrier	(30-day suspension) and 4
3342(b) or (e)	Failure to stop at railroad crossing	4

3344	Failure to stop when entering from alley, driveway or building	3
3345(a)	Failure to stop for school bus with flashing red lights and stop arm extended(60-day suspension) and ...	5
3361	Driving too fast for conditions	2
3362	Exceeding maximum speed:	
	Miles over Speed Limit:	
	6 to 10	2
	11 to 15	3
	16 to 25	4
	26 to 30	5
	31 and over(Departmental hearing and sanctions provided under Section 1538(d)) and...	5
3365(b)	Exceeding special speed limit in school zone	3
3365(c)	Exceeding special speed limit for trucks on downgrades	3
3542(a)	Failure to yield to pedestrian in crosswalk	2
3547	Failure to yield to pedestrian on sidewalk when entering from a driveway or alley	3
3549(a)	Failure to yield to blind pedestrians	3
3702	Improper backing	3
3714	Careless driving	3
3745	Leaving the scene of an accident involving property damage only	4

Point Removal for Safe Driving

Three points are removed from a driving record for every 12 consecutive months in which a person is not under suspension or revocation or has not committed any violation which results in the assignment of points or the suspension or revocation of the driving privilege. Once a driving record is reduced to zero and remains at zero points for 12 consecutive months, any further accumulation of points is treated as the first accumulation of points.

Suspensions and Revocations

If you are convicted of any one of the following traffic violations, your driving privilege will be suspended or revoked. **Please note this is only a partial listing.**

- Operating a motor vehicle while under the influence of drugs or alcohol
- Any felony involving a vehicle
- Homicide by vehicle
- Failure to stop when you are driving a vehicle involved in a crash (hit and run offense)
- Reckless driving
- Racing on highways
- Driving without lights to avoid identification
- Fleeing from a police officer
- Driving when your license is already suspended or revoked
- A second or any additional offense of driving without a valid license within a 5-year period
- Failure to stop for a school bus with its red lights flashing and stop arm extended (60-day suspension)
- Failure to comply with a railroad crossing gate or barrier (30-day suspension).

If a driving privilege is to be suspended or revoked, a written notice listing the date when the suspension/revocation will begin will be mailed to the driver. The driver's license must be returned to the Bureau of Driver Licensing by the effective date of suspension listed on the notice, or the State Police and local police will be notified to pick up the license. **NO** credit toward serving the suspension or revocation shall be earned until the driver's license is surrendered to PennDOT. In the case of an unlicensed driver, an Acknowledgement of Suspension/Revocation (Form DL-16LC) or an affidavit acknowledging the sanction must be surrendered to PennDOT in lieu of a driver's license. Drivers may appeal the suspension/revocation in the Court of Common Pleas (Civil Division) of their county of residence. The appeal must be filed **within 30 days** of the mailing date of the notice. In addition to serving the suspension or revocation, proof of payment for any fines and costs owed, proof of insurance (financial responsibility), and a restoration fee must be paid before driving privileges will be restored.

After the driving privilege is restored, the driving record will show five points, regardless of the number of points that appeared on the record before the license was suspended, except in the cases of:

- Underage drinking
- A 15-day suspension resulting from a hearing for the second accumulation of six points
- Suspension for failing to respond to a citation

Driving Without Insurance

- According to Pennsylvania state law, **YOU MUST MAINTAIN AUTOMOBILE LIABILITY INSURANCE ON YOUR REGISTERED MOTOR VEHICLE AT ALL TIMES.**
- If PennDOT finds that your vehicle was not covered by insurance for a period of 31 days or longer, your registration privilege will be suspended for three months. In addition, if you operated or permitted the operation of your vehicle without insurance, your driving privilege will also be suspended for a period of three (3) months.
- In order to have your driving and registration privileges restored, you must submit the following:
 - ◆ Proof that your vehicle is currently insured
 - ◆ An application for registration with the appropriate fees
 - ◆ The required restoration fees.

CRASHES

Do not stop at a crash unless you are involved or if emergency help has not yet arrived. Keep your attention on your driving and keep moving, watching for people who might be in or near the road. Never drive to the scene of a crash, fire or other disaster just to look. You may block the way for police, firefighters, ambulances, tow trucks and other rescue vehicles.

If you are in a crash, please follow the instructions listed below:

1. Stop your car at or near the crash scene. If you can, move your car off the road so you do not block traffic. Many crashes are caused when traffic stops or slows for an initial crash.
2. Call the police if anyone is hurt or dies. If the drivers of the cars are hurt and cannot call the police, then witnesses at or near the crash scene must call for help.
3. Call the police if any vehicle needs to be towed.
4. Get the information listed below from the other driver(s) involved in the crash:
 - Names and addresses
 - Telephone numbers

- Driver's license numbers
 - Registration numbers
 - Insurance company names and policy numbers
5. Get the names and addresses of:
 - Other individuals involved in the crash
 - Witnesses of the crash
 6. If the crash involves a parked car, stop immediately and try to find the owner. If you cannot find the owner, leave a note in a place where it can be seen and call the police. The note should include:
 - Your name and address
 - Your driver's license number
 - Your car's registration number
 - Date and time of the crash
 - Your insurance company's name and your policy number
 7. If the police do not investigate a crash and someone has died or been injured, or if a vehicle must be towed, send a Driver's Accident Report (Form AA-600) within five (5) days to:

PA Department of Transportation
Bureau of Highway Safety & Traffic Engineering
P.O. Box 2047
Harrisburg, PA 17105-2047

Please Note: To obtain a Driver's Accident Report (AA-600), contact your local or State Police.

DRIVING UNDER THE INFLUENCE OF ALCOHOL OR A CONTROLLED SUBSTANCE

Alcohol and Driving: A Deadly Mix

You probably know that in Pennsylvania and across the nation, drinking drivers are responsible for thousands of traffic deaths and injuries. In Pennsylvania, approximately 40% of all traffic deaths involve drinking drivers.

As a new driver, you might already know that even small amounts of alcohol will decrease your driving skills. You should also know that small amounts of alcohol will decrease experienced drivers' skills. No one can drink and drive safely.

Alcohol is a depressant—it slows you down. It affects all body cells, but especially affects the cells in the brain and central nervous system. As a result, alcohol limits your concentration, insight, perception, judgment and memory and it also slows down your movements and reactions.

As alcohol builds up in your blood, your driving errors will increase. Your reactions will slow down and you will lose the ability you had to control the car before you drank. There is a terrible effect that goes along with this. Even as alcohol robs your skills, it makes you feel dangerously confident, so drinking drivers can be out of control and not even know it.

Many people believe that only regular, heavy drinkers are dangerous drivers. But you should know that you do not have to drink much or drink often to be affected by alcohol. Studies show that blood alcohol levels well below the legal limit of .10% still greatly harm a driver's skills.

Drivers whose blood alcohol level is .05% (half the legal limit) are between two and seven times more likely to be involved in a crash than drivers who have no alcohol in their blood. So even if your blood alcohol level is well below the legal limit, your driving will still endanger your life and the lives of others. Remember: **The only sure way to drive safely is with “ZERO” alcohol in your system.**

What Constitutes a DUI (Driving Under the Influence)?

The penalties for driving while under the influence of alcohol or drugs are severe. In Pennsylvania, you are considered to be driving “while under the influence” if your blood alcohol level is .10% or higher unless you are under 21 years of age. If you are under 21, you are considered to be driving under the influence if your blood alcohol level is .02% or greater.

For drivers 21 years of age or older, do not drink more than one drink per hour. Your body needs at least one hour to process the alcohol in every drink you have. More than one drink per hour will push your blood alcohol level over the legal limit. For underage drinking drivers, Pennsylvania’s laws do not permit you to drive with any measurable alcohol in your system.

Pennsylvania’s Implied Consent Law (Chemical Testing for Alcohol or Drugs)

The “Implied Consent” law is very important to you as a driver. The law covering chemical testing says that you have agreed to take such a test—just by being licensed to drive in Pennsylvania. If the police arrest you for driving while under the influence of alcohol or drugs, and you refuse to take one or more chemical tests of breath, blood or urine, your driving privilege will be automatically suspended for one year in addition to the driving privilege suspension imposed for a conviction or Accelerated Rehabilitative Disposition for driving while under the influence. Even if you are found not guilty of driving while under the influence, your driving privilege will be suspended for 1 year if you refuse to take a blood, breath or urine test. Altogether, a conviction plus refusal could result in a 2-year driving privilege suspension.

**PLAY IT SAFE.
DO NOT DRIVE AFTER DRINKING ANY AMOUNT OF ALCOHOL,
AND
KEEP THE DRINKER FROM DRIVING!**

Severe Penalties

If you are accepted into the ARD program or convicted for the first time, you will:

- Lose your license for up to one year for ARD and one year minimum if convicted.
- Be sentenced to jail for a minimum of 48 hours if convicted.
- Pay a fine of between \$300 and \$5,000 in addition to related fees and other costs.
- Undergo alcohol and drug evaluation.
- If necessary, be ordered to undergo alcohol and drug rehabilitation treatment.
- Be required to participate in 12½ hours of Alcohol Highway Safety School.

Zero Tolerance Law (Under 21 DUI)

The Zero Tolerance law establishes serious consequences for those under 21 who drive with any measurable amount of alcohol in their blood. The law reduced the Blood Alcohol Content (BAC) from .10% to .02% for minors (under 21) charged with Driving Under the Influence.

Why Zero Tolerance?

Traffic crashes are the number one cause of death for teenagers in the United States.

Driving involves multiple tasks, the demands of which change continually. To drive safely, you must be alert and make decisions based on ever-changing information present in the environment and be able to maneuver based on these decisions. Drinking alcohol impairs a wide range of skills necessary for carrying out these tasks.

Drugs/Medication and Driving Impairment

Alcohol is not the only drug that will affect your driving. Many other drugs, used alone or together with alcohol, increase your risk of causing a crash.

Every drug has some effect on the person using it. Before taking a drug, find out from your doctor or pharmacist how this particular drug might affect your sight, coordination, timing and general ability to drive.

Amphetamines, methamphetamines, inhalants and hallucinogens may increase alertness and efficiency for a short time, but this effect may be followed by headaches, dizziness, irritability, loss of concentration and drowsiness. As these drugs wear off, alertness and driving ability will decrease.

Barbiturates affect a person's driving ability about the same way that alcohol does. They cause the driver to become drowsy, confused, less alert and visually impaired. Tranquilizers in small doses affect mostly a driver's outlook or attitude. In larger doses or together with other drugs or alcohol, tranquilizers may also cause dizziness or drowsiness.

Nonprescription and illegal drugs such as marijuana are just as dangerous. They affect your timing, judgment, distance perception, reaction time and general driving skills about the same way that alcohol does.

Any drug taken with alcohol can be dangerous. For example, one drink of alcohol with one tranquilizer equals the effect of four drinks. People using drugs, even if the drugs are prescribed by their doctors, should always avoid alcohol, **especially** if they plan to drive.

UNDERAGE DRINKING

Be aware that your driving privilege will be suspended if you are under 21 years of age and are convicted of lying about your age to obtain alcohol, carrying a false identification card, or purchasing, consuming, possessing or transporting alcohol. At a minimum, a 90-day suspension for the first offense, a one (1) year suspension for the second offense, and a two (2) year suspension for the third and subsequent offenses will be imposed. You will also face a fine of up to \$500 plus court costs **whether or not a motor vehicle was involved.**

If you do not have a driver's license, you will be ineligible to apply for a learner's permit for the time period of the suspension. If you are under 16 years of age, your suspension will not begin until your 16th birthday, **provided you acknowledge your suspension and it is received any time prior to your 16th birthday.**

In addition to serving a suspension, a restoration fee must be paid before your license will be returned or your application for a learner's permit considered for processing.

You will be subject to a fine, and the police are required to notify your parents. The court may then require you to be evaluated to determine the extent of your involvement with alcohol and may also require you to successfully complete a program of alcohol education, intervention or counseling.

Adults, whether or not they are parents, convicted of knowingly and intentionally supplying minors with alcohol are subject to a fine of at least \$1,000 for the first offense and \$2,500 for each additional offense and face up to one year in jail. Adults are even liable for guests who drink in their homes.

Here is an example of fines imposed for a party in a private home where underage individuals are drinking:

If you had 17 teenagers in your home for a party and they were drinking alcohol, the party could cost you \$41,000—\$1,000 for the first teenage drinker and \$2,500 for each of the other 16 drinkers.

If you are underage and are arrested and detained for blood, breath and/or urine testing, parental consent to conduct these tests is not required, but the police will notify your parents of the arrest. Penalties typically mirror those imposed on adults, often resulting in driving privilege suspension and enrollment in a treatment program. Drivers under 21 years of age may also face an automatic suspension of their driving privileges for one year or six months if placed in a consent decree program.

ONE FACT REMAINS: It is against the law for anyone under age 21 to consume, possess or transport alcohol. Again, remember—a motor vehicle does not have to be involved for you to lose your driving privileges if you are cited for underage drinking.

DO NOT risk the consequences.

CONTROLLED SUBSTANCE, DRUG, DEVICE AND COSMETIC ACT

Any person who possesses, sells, delivers, offers for sale, holds for sale or gives away any controlled substance, **whether or not a motor vehicle was used**, will upon conviction have his or her driving privilege suspended.

The terms of suspension will be as follows:

1. First offense: a period of six (6) months.
2. Second offense: a period of one (1) year.
3. Third and subsequent offenses: a period of two (2) years. Any multiple sentences imposed shall be served consecutively.

In addition to serving a suspension, you must also pay a restoration fee before your driving privilege will be restored or your learner's permit application, accompanied by appropriate fees, considered for processing.

DRIVER'S LICENSE COMPACT (DLC)

The DLC is a compact among member states and the District of Columbia to maximize law enforcement efforts nationwide. The major provisions of the DLC, which member states are committed to uphold and enforce, are:

- The "one driver license" concept, which requires the surrender of an out-of-state driver's license when application for a license in another state is made.
- The "one driver record" concept, which requires that a complete driver record be maintained in the driver's state of residence to determine driving eligibility in the home state, as well as for his or her nonresident operator's privilege in other jurisdictions.
- Reporting of all traffic convictions and license suspensions/revocations of out-of-state drivers to the home state licensing agency, as well as other appropriate information.

- The assurance of uniform and predictable treatment of drivers by treating offenses committed in other states as though they have been committed in the home state.

The following offenses, if committed in a member state, would be treated as though the offense had occurred in Pennsylvania, and the appropriate sanction would be imposed under the provisions of our Vehicle Code:

- Manslaughter or negligent homicide resulting from the operation of a motor vehicle (Section 3732).
- Driving a motor vehicle while under the influence of alcoholic beverages or a narcotic to a degree that renders the driver incapable of safely driving a motor vehicle (Section 3731).
- Failure to stop and render aid in the event of a motor vehicle accident resulting in the death or personal injury of another (Section 3742).
- Any felony in the commission of which a motor vehicle is used (*Crimes Code and Dangerous Drug Act Offenses*).

Although reported to PennDOT, minor traffic offenses such as speeding, running a red light or a stop sign, etc., will not appear on your driving record. Points will not be assessed to your Pennsylvania driving record when convicted of a point-related offense in a DLC member state. However, not responding to an out-of-state citation will result in the indefinite suspension of your Pennsylvania driving privilege until a response is made to the location indicated on the citation.

LAWS AND IMPORTANT ISSUES

This chapter will provide information you need to know about Pennsylvania laws and other important issues.

REQUIRED NOTIFICATION FOR CHANGE IN NAME OR ADDRESS

In accordance with Section 1515 of the Pennsylvania Vehicle Code, if your name or address is changed, you **must** notify PennDOT in writing within 15 days of that change even if moving out of state. You may report your address change by writing PennDOT or calling our Customer Call Center. You may change your name by completing an Application for Change/Correction/Replacement of Non-Commercial Driver's License (Form DL-80). By law, if you are registered to vote, this application will also change your voter registration address unless you check the appropriate block on the form. You will be issued a driver's license update card containing the new information. This card must be carried with your license. There is no fee for this service for non-commercial drivers. Commercial drivers are required to obtain and use an Application to Replace/Correct Commercial Driver's License (Form DL-80CD) and pay the required fee for a duplicate license.

SEAT BELT LAW

It is a law in Pennsylvania, in accordance with Section 4581 of the Vehicle Code, that all drivers and front seat passengers in automobiles, light trucks and motor homes must wear seat belts. Though it is not the law, it is strongly recommended that passengers riding in the back seat of a vehicle wear seat belts as well. For all drivers under the age of 18, the number of passengers may not exceed the number of seat belts in the vehicle.

You are required by law to buckle up. The following simple facts tell why it is a good idea to wear your seat belt:

Many people believe that they would be able to use their arms and legs to stop themselves from hitting the car's surfaces in a crash, but they are wrong. In most crashes, the bodies of the passengers and drivers hit the car's surfaces under several tons of force. This is enough force to shatter even the strongest of arms and legs.

Only seat belts can safely slow your body. You have only 1/50th of a second to stop your body after the car crashes. Arms and legs do not work that quickly, but seat belts do.

Seat belts slow your body down far more gently than a hard dashboard, steering wheel or windshield does. During a crash, fastened seat belts distribute the forces of rapid deceleration over larger and stronger parts of your body such as the chest, hips and shoulders. Supplemental airbags provide an even greater "ride down" benefit; however, even with an airbag present, a seat belt must be worn to protect the occupant in side impact and rollover crashes.

Seat belts and airbags save lives. They work best when everyone is buckled and children are properly restrained in the back seat.

CHILD RESTRAINT LAW

Automobile crashes are the leading cause of death and injury to children in the United States. In Pennsylvania each year, approximately 7,000 children below five (5) years of age are involved in crashes. So to protect Pennsylvania's children, the State Legislature passed Child Passenger Protection Act 53, which requires that:

- Children under the age of four (4) must be buckled into a federally-approved safety seat no matter where they ride in a motor vehicle—front or back seat.
- Drivers are responsible for securing children into an approved child passenger restraint system.

VIOLATORS MAY BE FINED AND WILL BE RESPONSIBLE FOR ALL COURT COSTS.

AIR BAG SAFETY INFORMATION

- Airbags are supplemental protection devices. Lap and shoulder belts must be worn to provide the best protection. Always wear the seat belt snugly across your hips and the shoulder strap across your chest away from your neck.
- Driver and front passenger seats should be moved as far back as practical, particularly for shorter statured people. It is suggested that you sit as far as comfortable and at least 12 inches away from the steering wheel.
- Hold the steering wheel at the 9 and 3 o'clock or 8 and 4 o'clock positions.
- Children 12 and under should ride buckled up in a rear seat.
- Infants in rear facing child safety seats should NEVER ride in the front seat of a vehicle with a passenger side air bag.
- Small children should ride in the rear seat in a child safety seat approved for their age and size.
- Read your vehicle owner's manual and the instructions provided with all child safety seats for correct use.

AMERICANS WITH DISABILITIES ACT (ADA)

In order to comply with the Americans With Disabilities Act of 1990, PennDOT has made all Driver License Centers and Photo License Centers accessible to physically disabled individuals. In addition, the following services are available to people who want to take the driver's examination and have a hearing or reading impairment.

Interpreters for the Deaf and Hearing Impaired

PennDOT's Bureau of Driver Licensing will provide an interpreter upon request for individuals who are hearing impaired and communicate through the use of sign language and who want to take the driver's exam or have to take a special driving exam. In order for an interpreter to be present when you take the exam, you must take the following steps:

1. Call 1-800-932-4600 to set up an appointment to take your Driver's Exam. If you use a TDD, you should call 1-800-228-0676 (Out-of-state TDD users should call 1-717-391-6191). Indicate at which Driver License Center you want to take the test and give at least three dates on which you will be able to take the exam. When setting up an appointment to take your driver's exam, you may also use the Pennsylvania Relay Service. This service provides telephone communication between a person who has a TDD system and one who does not. This system uses an operator to act as a go between for calls between hearing and non-hearing parties. If a person has a TDD system, he/she should use 1-800-654-5984 when accessing the Pennsylvania Relay Service. If the person accessing the Service is a hearing caller, he/she should use 1-800-654-5988.

When an interpreter has been hired to assist you with your driver's exam, you will be called back to have your exam date confirmed.

2. When making your appointment, you should indicate if there is a type of sign language you prefer to use. The types available are:
 - American Sign Language (ASL)
 - Pidgin Sign Language (PSE)
 - Signed Exact English (SEE)
 - An oral interpreter (a person who reads lips).

PennDOT will do its best to secure a person who signs in your preference.

3. Make your initial contact with PennDOT at least two (2) weeks prior to the time you want to take the exam.

Alternative Testing Method

Some people who take the driver's exam may have trouble reading or, in some cases, may not be able to read and would feel more comfortable if the test were read to them. Upon request, voice tests are offered at all Driver License Centers across the Commonwealth.

PARKING AREAS FOR PERSONS WITH DISABILITIES

According to Pennsylvania law, there are two conditions necessary before an individual may legally park in a designated parking area for persons with disabilities:

1. The vehicle being parked must bear a disabled person or disabled veteran registration plate/parking placard
2. The vehicle must be operated by or for the transportation of the disabled person or severely disabled veteran.

Any vehicle unlawfully parked in a parking area for disabled persons may be removed from that area by towing and reclaimed on payment of the towing costs. This parking violation is a summary offense. Individuals convicted of this offense will be fined between \$50.00 and \$200.00.

ORGAN DONOR DESIGNATION

Each time you renew your Pennsylvania driver's license, you will be asked if you want the "ORGAN DONOR" designation on your license. You should give thought to this decision before going to the Photo License Center to have your photo taken. The words "ORGAN DONOR" will appear on your driver's license when you say "YES" to be designated as an organ donor at the Photo Center.

Applicants under 18 years of age may request and obtain the organ donor designation on their driver's license; however, they must have written consent from a parent, guardian, person in loco parentis or spouse. The parent or guardian may give consent by checking the appropriate block on the Parent or Guardian Consent Form (DL-180TD).

Organ Donation Awareness Trust Fund

You have the opportunity to donate \$1.00 to the Organ Donation Awareness Trust Fund (ODTF). The trust fund will create funding to support the various organ donation programs across the Commonwealth and provide for public information concerning these programs.

Many of our driver license forms have been revised to include a block for you to check if you wish to contribute to the fund and to ensure proper handling of your contribution. The \$1.00 contribution must be added to the required driver license fee and be included in your payment when you send your form to PennDOT.

ANTI-LITTERING LAW

It is against the law to drop, throw or deposit upon any highway, upon any other public or private property (without the consent of the owners thereof) or into or on the waters of this Commonwealth, from a vehicle, any waste paper, sweepings, ashes, household waste, glass, metal, refuse or rubbish or any dangerous or detrimental substance, or permitting any of the preceding without immediately removing such items or causing their removal.

A violation of this law, including any violation resulting from the conduct of any other persons present within any vehicle of which you are the driver, may result in a fine of up to \$300 upon conviction.

BICYCLE HELMET LAW

Pennsylvania law requires all children under the age of 12 when operating or riding as a passenger on a pedalcycle or in a trailer towed by a pedalcycle, to wear an approved bicycle helmet meeting CPSC, ANSI, SNELL, ASTM or any other nationally recognized certification. The law excludes operators of three-wheeled pedal-driven vehicles that have a main driving wheel of 20 inches in diameter or less and are primarily designed for children six (6) years of age or younger.

PASSENGERS IN AN OPEN BED TRUCK

An open-bed pickup truck or open flatbed truck may not be driven at a speed of more than 35 miles per hour if any person is occupying the bed of the truck. Such a truck may not be driven at any speed if a child less than 18 years of age is occupying the bed of the truck.

Exceptions to this law are:

- A child of a farmer who is being transported between parts of a farm or farms owned or operated by the farmer in order to perform work on the farm or farms.
- A child possessing a valid hunting license who is being transported between a hunting camp and a hunting site or between hunting sites during hunting season.
- A child who is a participant in an officially sanctioned parade, only during the course of the parade.
- A child employed to perform farm labor who is being transported between parts of a farm or farms owned or operated by the child's employer or employers.

REFERENCES

This chapter will provide a quick reference concerning helpful information, forms, publications and literature.

CUSTOMER CALL CENTER

**Information regarding driver and vehicle services is available
24 hours if using a touchtone (pulse-tone) telephone.**

Service Representatives are available between the hours of
7:00 a.m. to 9:00 p.m. — Monday through Friday

For direct assistance except on major holidays:

In-State

Out-of-State

1-800-932-4600

1-717-391-6190

TDD • 1-800-228-0676

TDD • 1-717-391-6191

ROAD TEST AND SPECIAL POINT EXAMINATION APPOINTMENTS

Appointments **MUST** be made to take the Special Point Examination and the Non-Commercial Skills Test in most cases. To make an appointment or to find out if one is necessary, call the Customer Call Center at 1-800-942-3926 between the hours of 7:00 a.m. to 8:00 p.m.

Remember: If you are under 18 years of age, you may not take your Road Test for six (6) months after you have received your learner's permit and have completed the 50 hours of behind-the-wheel skill-building requirements.

CUSTOMER CORRESPONDENCE MAILING ADDRESS

When writing to PennDOT requesting specific forms or any additional information, you may contact our Correspondence Unit at:

Bureau of Driver Licensing

P.O. Box 68618

Harrisburg, PA 17106-8618

*NOTE: For all inquiries other than form requests, be sure to include your driver's license/photo identification/learner's permit number. If these numbers are unavailable, your date of birth **MUST** be furnished. Please also include a telephone number where you can be reached during the day.*

DEPARTMENTAL FORMS AND PUBLICATIONS

The forms and publications listed below are available at all Driver License Centers and most messenger services, notaries and auto clubs.

Forms

Form	DL-31	Application to Add/Extend/Replace/Change/Correct Non-Commercial Learner's Permit
Form	DL-54B	Application for Change/Correction/Replacement/Renewal of a Pennsylvania Photo Identification Card
Form	DL-59	Application for Change from a Junior Driver's License to a Regular Non-Commercial License
Form	DL-80	Application for Change/Correction/Replacement of Non-Commercial Driver's License
Form	DL-81	Application for Non-Driver Photo Identification Card for Pennsylvania Drivers
Form	DL-130	Request for Letter of Clearance

Forms

Form	DL-135	Request for Vehicle Information
Form	DL-143	Non-Commercial Driver License Renewal Application
Form	DL-180	Non-Commercial Learner's Permit Application
Form	DL-180C	Parent or Guardian Certification
Form	DL-180PG	Parent or Guardian Notification
Form	DL-180TD	Parent or Guardian Consent Form
Form	DL-298	Serviceperson Request for Non-Commercial Pennsylvania Driver's License
Form	DL-503	Request for Driver Information
Form	DL-8611	Request for Organ Donor Designation on Pennsylvania Driver's License or Photo ID Card
Form	MV-44	Application for Duplicate Registration Card; Replacement of Registration Plate, Renewal Sticker or Weight Class Sticker; or Transfer of Registration
Form	MV-63	Change of Address for Pennsylvania Driver's License, Photo ID and Vehicle Registration
Form	MV-140	Request for Registration
Form	MV-145	Application for Person with Disability, Hearing Impaired, Disabled Veteran or Severely Disabled Veteran Registration Plate or Person with Disability or Severely Disabled Veteran Motorcycle Plate Decal
Form	MV-145A	Person with Disability Parking Placard Application
Form	MV-904	Application for Special Registration Plate

Publications

Pub	95	Pennsylvania Driver's Manual (English Version)
Pub	95S	Pennsylvania Driver's Manual (Spanish Version)
Pub	147	Motorcycle Operator Manual
Pub	174	Vehicle Transfer after Death of Owner
Pub	176	Armed Forces Personnel (Pennsylvania Vehicle Registration and Driver's License Information)
Pub	179	Buying or Selling Your Car in Pennsylvania
Pub	385	How to Steer Them to Safe Driving Tutor Guide (English Edition)
Pub	386	What You Need to Know About Pennsylvania's Young Driver Law
Pub	388	How to Steer Them to Safe Driving Tutor Guide (Spanish Edition)

INTERNET

The following forms are now available on the Internet for customer convenience and are located on PennDOT's Home Page, accessible via the Pennsylvania State Web site at www.state.pa.us or PennDOT's Web site at www.dot.state.pa.us and click on Driver and Vehicle Services. The forms have a slightly different appearance when printed from the Internet.

Form	DL-31	Application to Add/Extend/Replace/Change/Correct Non-Commercial Learner's Permit
Form	DL-80	Application for Change/Correction/Replacement of Non-Commercial Driver's License
Form	DL-135	Request for Vehicle Information
Form	DL-143	Non-Commercial Driver License Renewal Application
Form	DL-176	Military Status Endorsement Card
Form	DL-180	Non-Commercial Learner's Permit Application

Form	DL-180C	Parent or Guardian Certification
Form	DL 180 PG	Parent or Guardian Notification
Form	DL-180TD	Parent or Guardian Consent Form
Form	DL-503	Request for Driver Information
Form	MV-44	Application for Duplicate Registration Card; Replacement of Registration Plate, Renewal Sticker or Weight Class Sticker; or Transfer of Registration
Form	MV-140	Request for Registration
Pub	176	Pennsylvania Residents in the Armed Forces
Pub	385	How to Steer Them to Safe Driving Tutor Guide (English Edition)
Pub	386	What You Need to Know About Pennsylvania's Young Driver Law
Pub	388	How to Steer Them to Safe Driving Tutor Guide (Spanish Edition)

Also available are the following:

Driver License Center Information and Clickable Location Map.

PennDOT's New Resident Packet for Driver and Vehicle Services.

Pennsylvania's Driver's Manual can now be viewed on-line or printed by chapter. The Non-Commercial Learner's Permit Application (DL-180) and the Parent or Guardian Consent Form (DL-180TD) can be printed separately.

STATEWIDE AND COUNTY MAPS

For information on statewide and county maps, call 1-717-787-6746, Monday through Friday, except holidays, between the hours of 8:00 AM and 4:00 PM.

INFORMATION ON OTHER PROGRAMS

Other publications on safe driving available from PennDOT are listed below. To get copies, write to the Bureau of Highway Safety and Traffic Engineering, P.O. Box 2047, Harrisburg, PA 17105-2047.

- Occupant Protection materials (seat belt/child restraint)
- Alcohol Awareness related materials
- General Safety materials
- Crash Scene Do's and Don'ts
- Operation Lifesaver materials
- Pennsylvania Bicycle Driver's Manual

The United States Department of Transportation has an Auto Safety Hotline at 1-800-424-9393 or on the Internet at www.nhtsa.dot.gov.

Topic	Page	Topic	Page
Accelerating	50	Stalled Engine	52
Accelerator Sticks.....	52	Headlight Failure	52
Accidents (See Crashes)		Accelerator Sticks.....	52
Address, Change	64	Drifting Off the Pavement.....	53
Address, Mailing	68	Deaf and Hearing Impaired, Interpreters for the.....	65
Adjusting Speed	41	Drive, Preparing to	23
Air Bag Safety Information	65	Driver's License Compact (DLC)	62
Alcohol and Driving: A Deadly Mix	59	Driver's License:	
Alertness (How it Can Affect Your Driving).....	53	Who Needs a Pennsylvania?	2
Alternative Testing Method	66	Junior Permit Information	3
Americans with Disabilities Act (ADA)	65	Junior Driver License Information.....	3
Anger and Aggression	53	What Class Do You Need?.....	4
Appointments:		Driving in Traffic	37
Road Test	68	Driving Record Information.....	56
Special Point Examination	68	Driving Skills, Developing	28
Backing Up	32	Drugs/Medication and Driving Impairment	61
Bicyclists	46	Emergency Driving Skills	50
Bicycle Helmet Law	67	Steering	50
Blind Pedestrians	9	Accelerating	50
Blowout	52	Braking	50
Brakes:		Signals, Using.....	35
Condition of	43	Emergency Vehicles/Situations	45
Brake Failure	52	Emissions, Vehicle Safety Inspection	23
Braking	50	Flooded Roadways	42
Buses	49	Foreign License Holders.....	2
School.....	44	Forms and Publications, Departmental	68
Changing Lanes	32	"Four-Second Rule" The	28
Child Restraint Law.....	64	Funeral Procession.....	45
Class of Licenses	4	Guide Signs	18
Clutch, Using the	24	Headlights:	
Communication	34	Using Your	33
Completing the Turn	37	Headlight Failure	52
Controlled Substance:		Health:	
Driving Under the Influence (DUI)	59	Seizure Disorders (Epilepsy and Others).....	54
Drug, Device and Cosmetic Act	62	Diabetes	54
Crashes.....	58	Heart Condition.....	54
Crossing Traffic.....	38	Hearing.....	54
Curves.....	43	Horn, Using Your.....	35
Customer Call Center	68	Horseback Riders and Horse-Drawn Vehicles	46
Dangerous Driving Conditions:		Information on Other Programs	70
And Vehicle Emergencies, Handling	50	Inspection, Vehicle Safety and Emissions	23
Skidding	51	Insurance, Driving Without	58
Slippery Surfaces—Road Conditions	51	Internet	69
Brake Failure	52	Interpreters for the Deaf and Hearing Impaired	65
Blowout.....	52	Intersections	37

Topic	Page	Topic	Page
Interstate Route Numbering System	19	Mirrors.....	24
Junior Driver License Information.....	3	Motorcycles and Mopeds	45
Junior Permit Information	3	Name, Change in	64
Keeping a Space Cushion Around Your Vehicle.....	28	Night, Driving at	32
Keeping in Shape for Driving	53	Headlights, Using Your.....	33
Alertness.....	53	Organ Donation Awareness Trust Fund	66
Anger and Aggression	53	Organ Donor Designation.....	66
Vision	53	Parking	40
Hearing.....	54	Areas for Persons with Disabilities.....	66
Health	54	Passing:	
Keeping Your Vehicle Where It Can Be Seen	30	Safe Procedures.....	39
Laws:		On a Two-Lane Road	39
Insurance, Driving Without	58	On the Right	40
Driving Under the Influence of Alcohol		On Multi-Lane Highways	40
or a Controlled Substance	59	Restrictions.....	40
Zero Tolerance (Under 21 DUI)	60	Pavement:	
Implied Consent (Chemical Testing for		Markings.....	21
Alcohol or Drugs)	60	Drifting Off the	53
Underage Drinking	61	Pedestrians.....	49
Controlled Substance, Drug, Device		Signals	8
and Cosmetic Act.....	62	Blind	9
Driver's License Compact (DLC)	62	Point System, Pennsylvania's.....	56
Required Notification for Change in		Point Removal for Safe Driving	57
Name or Address	64	References	68
Seat Belt.....	64	Railroad Crossings	49
Child Restraint	64	Railroad Crossing Signal	9
Americans with Disabilities Act (ADA)	65	Regulatory Signs	10
Parking Areas for Persons with Disabilities	66	Road, Conditions of the:	
Anti-Littering	66	Slippery Roads/Surfaces	41, 51
Bicycle Helmet	67	Water on the Roadway.....	42
Passengers in an Open Bed Truck	67	Flooded Roadways.....	42
Learner's Permit:		Slick Winter Roads	42
Applying for a	1	Curves	43
Junior Permit Information	3	School Buses	44
Junior Driver License Information.....	3	Seat, Adjust the Driver's	23
Leaving Highway Traffic	39	Seat Belt, Fasten Your	23
Looking:		Seeing Clearly	31
Ahead	31	Signaling:	
To the Sides	31	When Changing Direction	34
Behind	32	When Slowing Down or Stopping.....	35
Maps, Statewide and County	70	Using Emergency Signals	35
Merging With Highway Traffic.....	38	Before Turning	36
Military Personnel	3		

Topic	Page	Topic	Page
Signals (Traffic):		Tires:	
Lights and Arrows.....	7	Condition of	43
Flashing	8	Blowout.....	52
Non-Functioning Traffic Lights	8	Traffic:	
Lane Use Control	8	Handling Traffic Conditions One at a Time.....	30
Pedestrian	8	Driving in.....	37
Railroad Crossing Signal	9	Intersections	37
Signs:		Crossing, Merging and Leaving	38
Regulatory	10	Flow	43
Warning	13	Reactions to Slow-Moving	43
Objects Adjacent to the Roadway	16	Traffic Lights (See Signals)	
Work Zone	16	Trip Planning.....	54
Electronic Arrow Panels	17	Trucks:	47
Flagger Ahead	17	Passing a	47
Guide	18	Truck Passing.....	47
Freeway/Expressway	18	Following a	47
Service	19	Turns.....	48
Tourist-Oriented Directional	19	Backing Crashes	48
Interstate Route Numbering System	19	Braking	48
Route Markers	19	Escape Ramps	48
Mile Markers.....	20	Turning:	
Skidding	51	At a Red Light.....	12, 37
Slippery Roads	41	U-Turns	11, 37
Slow-Moving Traffic, Reactions to	43	Signaling Before	36
Social Security Number Information	2	Positioning Your Vehicle	36
Space Cushion Around Your Vehicle	28	Making the Turn	36
Ahead	28	Completing the Turn	37
"Four-Second Rule" The.....	28	Underage Drinking	61
To the Sides	29	Vehicle, Checking Your	25
Behind	29	Vision	53
Special Circumstances.....	29	Vision Standards.....	2
Speed:		Warning Signs.....	13
Adjusting.....	41	Water on Roadway	42
Posted Limits	43	Winter Roads, Slick	42
Stalled Engine.....	52	Work Zone Signs	16
Steering.....	50	Zero Tolerance Law (Under 21 DUI).....	60
Suspensions and Revocations of Driving Privilege	57		
Telephone (See Customer Call Center)			
Tests:			
Knowledge	4		
Alternative Testing Method	66		
Road.....	5		
If You Pass the Test	6		
If You Fail the Test	6		

THEY'LL NEVER FORGET THE THOMPSONS' PARTY.

Neither will the Thompsons. Because the law says any adult who gives or sells beer, wine, wine coolers or liquor to a person under 21 faces up to a year in jail, a minimum fine of \$1,000 for the first kid served, and \$2,500 for each additional minor. Giving your own son or daughter a drink is illegal, too. Before you make a mistake, call or write for our free brochure, and read it. We guarantee it's something you'll remember for a long, long time.



Pennsylvania Liquor Control Board
Northwest Office Building
Harrisburg, PA 17124

Pennsylvania Chapter
American Academy of Pediatrics

Commonwealth of Pennsylvania
Department of Transportation

IMPORTANT WORDS TO REMEMBER

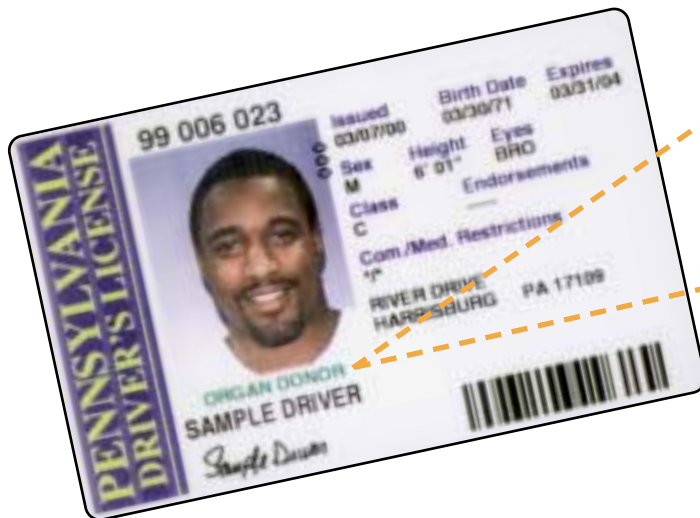

ORGAN DONOR

WHEN YOU GET YOUR LICENSE, REMEMBER THESE IMPORTANT WORDS

They're important words to thousands who await life-saving organ and tissue transplants. Words that could help others regain sight through cornea transplants, heal from burns more quickly with donated skin, or walk without pain with transplanted bone.

Be sure to discuss organ and tissue donation with your family because organs and tissues cannot be donated without consent of your family or next-of-kin.

SOME QUICK FACTS ABOUT ORGAN AND TISSUE DONATION

- Almost anyone from newborns to adults can be donors.
- All major religions support donation.
- Donation is considered only after death is declared.
- Donation does not hinder funeral arrangements.
- There is no cost to the family of the donor.

TO GET AN ORGAN AND TISSUE DONOR CARD, CALL:

PA Department of Health.....1-800-692-7254
In Eastern and Central Pennsylvania:

Delaware Valley Transplant Program 1-800-543-6391
In Western and Central Pennsylvania:

Center for Organ
Recovery & Education1-800-366-6777

For additional organ and tissue resource information, call:

PA Department of Health.....1-800-692-7254
